

MOX

PRODUCT CATALOG

LED LIGHTING, CABLE ORGANIZATORS, STYLISH AND CUSTOMIZABLE PROFILES SKIRTING BOARDS

LUCEO	10
guiding light source for security purposes, as well as to enjoy the touch of light in design	
LEUX	12
brings classical designs and modern lighting together	
WISHLED	14
suitable for any environment with unlimited design	
LATO	16
ideal for all living spaces with minimal, slim design. practical corner solutions	
SOLE	18
designed for all classical, luxurious and prestigious living spaces	
CRISPO	20
for areas with large gaps between wall and flooring	
SENTIO	22
order cables in areas such as workplaces and put an end to the mess	
VELO	24
provides sealing and eliminates joint defects to floor-wall joints in wet areas	
GRAVITY	26
complementary element of your interior designs	
MPS-F	28
prevents moisture penetration to joints and reduces sound transmission in the impact zone	

CERAMIC BORDERS, TILE TRIM PROFILES CERAMIC PROTECTION PROFILES

MONO-FIX	32
ceramic protection with an elegant appearance	
ROUND-FIX	34
elevate your ceramic applications: seamless style, unmatched protection	
SQUARE-FIX	36
flawless appearance on ceramic surfaces, wide range of color and effect options to adapt trending ceramic colors and textures	
MPS-AG	38
an elegant appearance that softens the transition of the outer corners	

MPS-BRD	40
decorative border profile for ceramic surfaces	
MPS-C	42
Quality of stainless steel for inner corners of ceramic applications	
MPS-D	44
provides perfect appearance to ceramic surfaces and prevents damage to ceramics with the quality of stainless steel	
MPS-L	46
Pure and minimal appearance to ceramic combinations with its simple design	
MPS-S	48
softens the transition in the inner corners and provides an elegant appearance	

RAMP TRANSITIONS, CARPET EDGE PROTECTION, FLOORING AND RENOVATION, STEP NOSE PROTECTION

ALL IN ONE	52
with its adjustability, it provides a flawless appearance to floor transitions	
REVIO	54
designed to enhance the aesthetics and functionality of your flooring	
VISIO	56
enhance your flooring transition with a stylish carpet threshold profile	
LINE	58
perfect choice for your flooring with its minimalist form	
FLEX	60
create imaginative designs for your flooring with its formable form	
MPS-E	62
suitable for all architectural designs with its traditional but enhanced appearance	
MPS-N	64
softens the transition between different levels	
MPS-TB	66
with the T shape, provides the simple look of traditional transitions	
MPS-YD	68
absorbs the pressure of building expansions and provides protection to ceramics	
MPS-B	70
eliminates application errors of stairs such as marble and parquet	

ABOUT MOX

Orego Metal, one of the main suppliers of well known international brands, has entered the Turkey market with Mox Profile Systems by maintaining high quality raw material, correct operation and perfect surfaces which led it to become a favorite brand for many customers in the World and especially in Europe.

We assure that your application places will be both aesthetically pleasing and distinguishable, with our wide range of products including skirting boards, tile trims, stair nose profiles, flooring transition and ramp transition profiles with aluminum and stainless steel materials.

We promise not only to provide quality product and service for applying all processes with the same precision for transforming raw material to aluminum decorative profile, but also best prices by means of our manufacturing capabilities.

Always prioritizing customer satisfaction and respecting their feedback plays the most important role in increasing our growth figures every year in the European, American, Middle Eastern and African markets.

DESIGN

We are here with our technical team to be your solution partner for your application areas. We offer both our standard products or if required non-standard products that are customized according to your need. With being a manufacturer and having nearly 3,000 existing molds, we can offer non-standard solutions.

MOLDING

If our existing products do not provide the solution you need, our design team will work in coordination with you to design a product according to your request and provide complete technical details. According to your annual consumption numbers and your surface type and quality expectation, we optimize and produce the mold in our own workshop so that the design is not shared with any third parties.

PROJECT MANAGEMENT

We offer and deliver custom profiles up to 6m length, in order to save you from cutting work and cost of waste. We have the capability of producing unlimited RAL color in our own integrated powder coating facility, and silver, yellow, bronze, inox and black color options for matte and bright surfaces in our anodizing facility. Chrome plating and nickel colors in profiles up to 3 meters are also among our production capabilities.

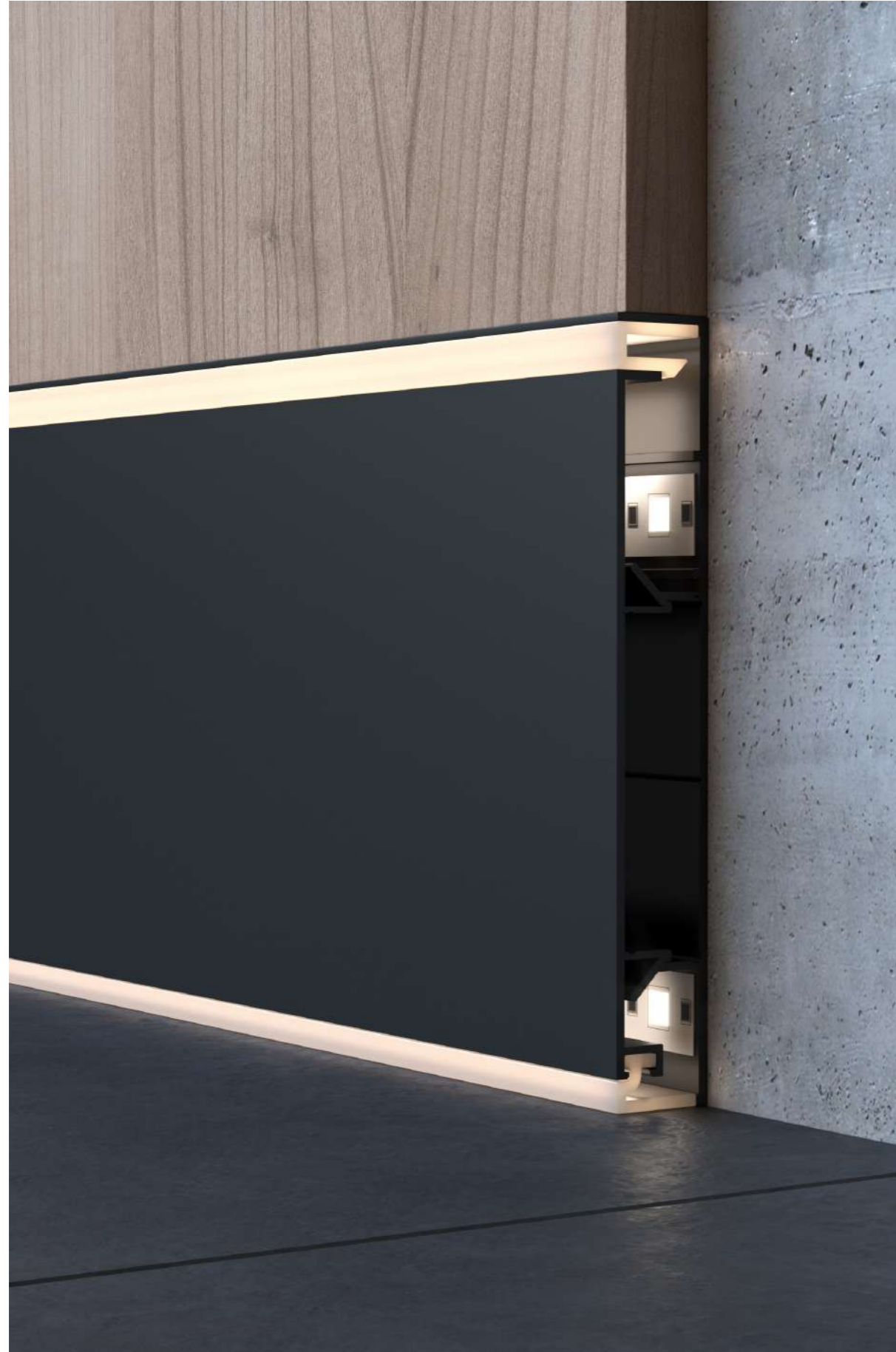

LED LIGHTING, CABLE ORGANIZATORS,
STYLISH AND CUSTOMIZABLE PROFILES
SKIRTING BOARDS

Mox skirting boards cover the defects in floor and wall joints. They prevent dirt accumulation and harmful organisms to provide hygienic and healthy use for many years.

LUCEO

Aluminum LED Skirting Board

Luceo aluminum LED skirting board is mostly preferred in exclusive projects through its decorative lighting feature. It can also be used as a guiding light in dark places. In addition to its illumination feature, it also covers the defects in floor and wall joints. It prevents dirt accumulation and harmful organisms to provide hygienic and healthy use for many years. With the hollow area in its design, it collects the telephone, electricity and internet cables to organize your environment. Luceo has a plain and minimal appearance with its slim form. Luceo has matte anodized, bright anodized, satin chemical bright anodized and electrostatic powder painting options. While silver, yellow, inox, bronze and black anodized color coatings are available, it can also be painted to the desired RAL code with electrostatic powder painting.



GUIDING LIGHT SOURCE FOR SECURITY PURPOSES, AS WELL AS TO ENJOY THE TOUCH OF LIGHT IN DESIGN

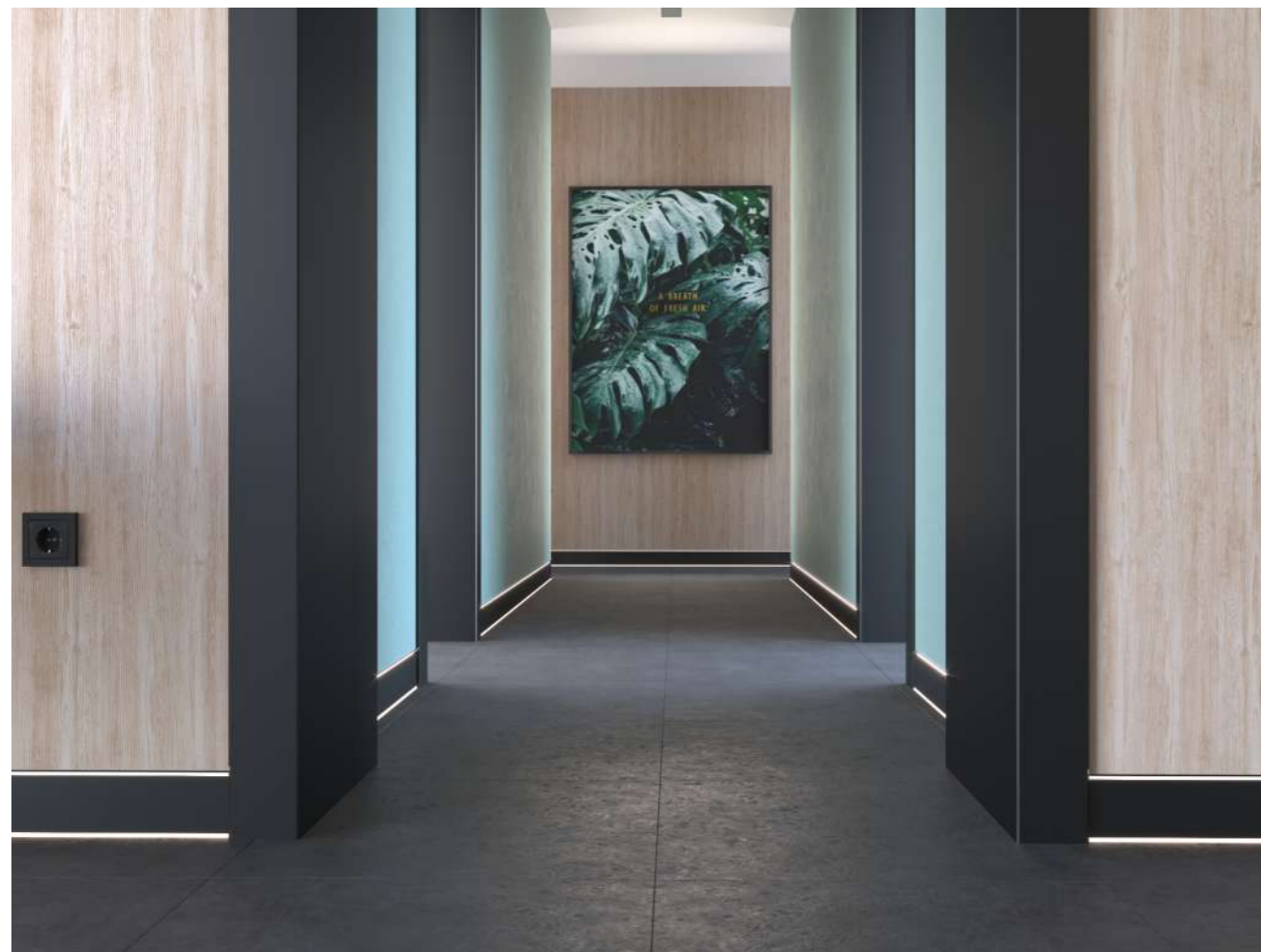

Product No	Height		Length		Surface
	mm	in	mm	ft	
LCE250100013MEGMS	100	3-15/16	2500	8 1/5"	MEGMS
LCE250100013R9005	100	3-15/16	2500	8 1/5"	R9005
LCE250100013R9016	100	3-15/16	2500	8 1/5"	R9016
LCE250100013R7016	100	3-15/16	2500	8 1/5"	R7016
LCEEXT100013COLOR - External Corner					
LCEINT100013COLOR - Internal Corner					
LCEEND100013COLOR - End Cap					

BUILT-IN OPTION

With its built-in or basic application methods, it can be flush to wall or used as a traditional skirting board.

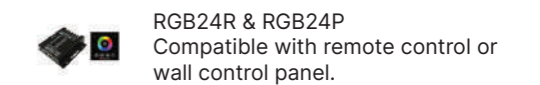
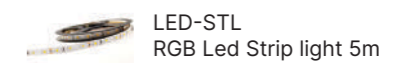
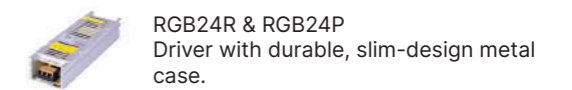
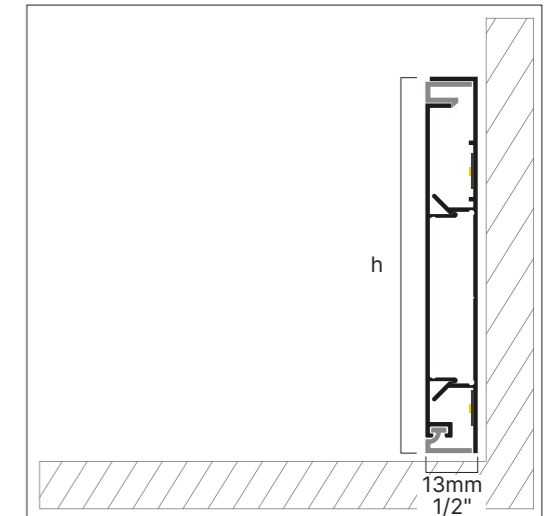
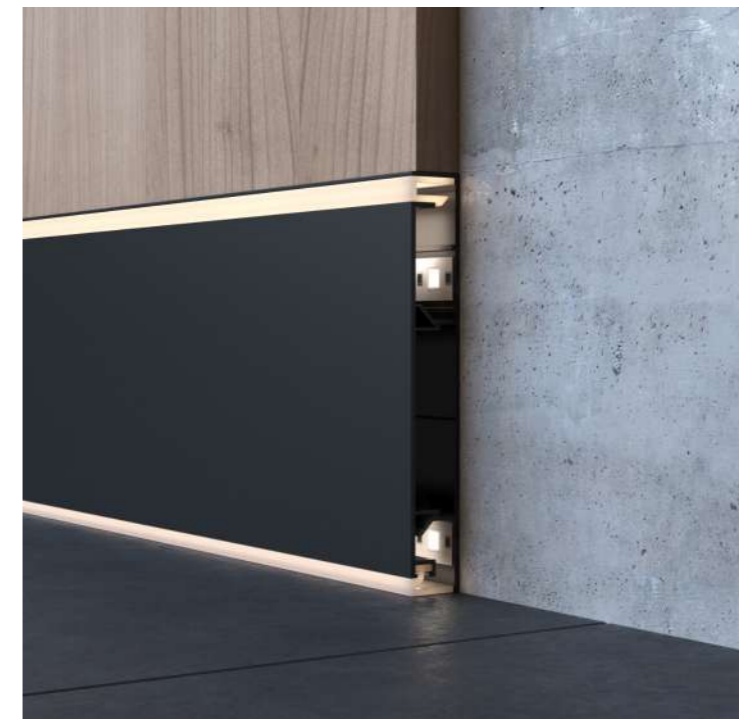

CORNER SOLUTIONS

With its built-in or basic application methods, it can be flush to wall or used as a traditional skirting board.



LEUX

Aluminum LED Skirting Board

Leux aluminum LED skirting board is mostly preferred in exclusive classical design projects through its decorative lighting feature and Victorian design. It can also be used as a guiding light in dark places. In addition to its illumination feature, it also covers the defects in floor and wall joints. It prevents dirt accumulation and harmful organisms to provide hygienic and healthy use for many years. With the hollow area in its design, it collects the telephone, electricity and internet cables to organize your environment. Leux brings classical appearance and modern lighting together. Leux is an eclipse series product. Aluminum products with eclipse marker have RAL7016 and RAL9016 color options.



BRINGS CLASSICAL DESIGNS AND MODERN LIGHTING TOGETHER



Product No	Height		Length		Surface
	mm	in	mm	ft	
LUX250100020MEGMS	100	3-15/16	2500	8 1/5"	MEGMS
LUX250100020RR9005	100	3-15/16	2500	8 1/5"	R9005
LUX250100020R9016	100	3-15/16	2500	8 1/5"	R9016
LUX250100020R7016	100	3-15/16	2500	8 1/5"	R7016
LUXEXT100020COLOR - External Corner					
LUXINT100020COLOR - Internal Corner					
LUXEND100020COLOR - End Cap					

BUILT-IN OPTION

With its built-in or basic application methods, it can be flush to wall or used as a traditional skirting board.

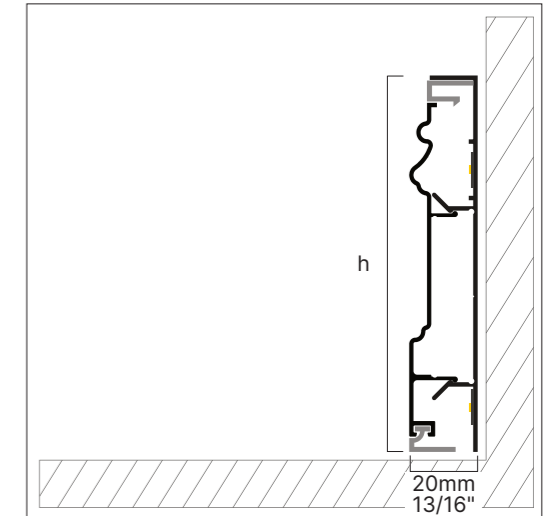

-  MEGMS
matte silver, anodized
-  R9005
black, semi gloss,
powder coated
-  R9016
white, semi gloss,
powder coated
-  R7016
anthracite, semi gloss,
powder coated

 RGB24R & RGB24P
Driver with durable, slim-design metal case.

 LED-STL
RGB Led Strip light 5m

 RGB24R & RGB24P
Compatible with remote control or wall control panel.

CORNER SOLUTIONS

With its built-in or basic application methods, it can be flush to wall or used as a traditional skirting board.



WISHLED

Aluminum LED Skirting Board

Wishled aluminum LED skirting board can match with any environment due to its unlimited pattern designs options. It is mostly preferred as night lighting in children's rooms with its replaceable design printed cover. It can also be used for advertising and to present corporate identity in public areas. In addition to its illumination feature, it also covers the defects in floor and wall joints. Application will be completed by mounting the front design printed diffuser panel with its snap lock system. With the inner, outer and end covering caps, which are the same color as the profiles, smooth corner turns can be easily applied without the need for an angled cut. Wishled has matte anodized, bright anodized, satin chemical bright anodized and electrostatic powder painting options. While silver, yellow, inox, bronze and black anodized color coatings are available, it can also be painted to the desired RAL code with electrostatic powder painting. In addition to existing pattern designs we offer for the illumination panel, personalized designs can also be applied.



SUITABLE FOR ANY ENVIRONMENT WITH UNLIMITED DESIGN



Product No	Height		Length		Surface
	mm	in	mm	ft	
WSL250100020MEGMS	100	3-15/16	2500	8 1/5"	MEGMS
WSL250100020R9005	100	3-15/16	2500	8 1/5"	R9005
WSL250100020R9016	100	3-15/16	2500	8 1/5"	R9016
WSL250100020R7016	100	3-15/16	2500	8 1/5"	R7016
WSLEXT100020COLOR - External Corner					
WSLINT100020COLOR - Internal Corner					
WSLEND100020COLOR - End Cap					

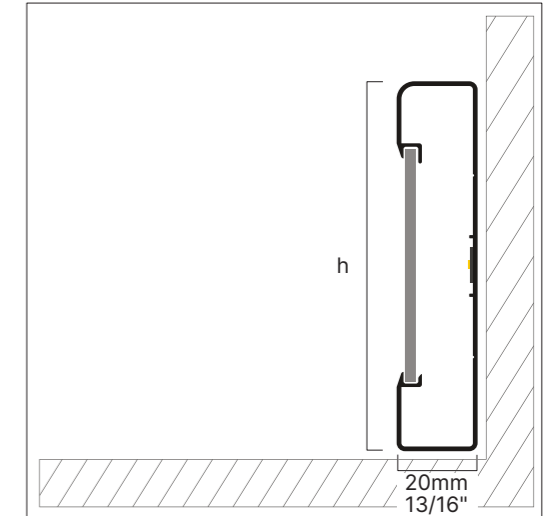

	
MEGMS matte silver, anodized	R9005 black, semi gloss, powder coated
	
R9016 white, semi gloss, powder coated	R7016 anthracite, semi gloss, powder coated

 RGB24R & RGB24P
Driver with durable, slim-design metal case.

 LED-STL
RGB Led Strip light 5m

 RGB24R & RGB24P
Compatible with remote control or wall control panel.

CORNER SOLUTIONS

With its built-in or basic application methods, it can be flush to wall or used as a traditional skirting board.



LATO

Aluminum Skirting Board

Lato aluminum skirting board is mostly preferred in all living areas and public areas such as offices, hotels, hospitals, schools, shopping malls and terminals. It has aluminum corner pieces with surface and color options identical to profiles. It covers the defects in floor and wall joints. It prevents dirt accumulation and harmful organisms to provide hygienic and healthy use for many years. With the hollow area in its design, it collects the telephone, electricity and internet cables to organize your environment. Lato has matte anodized, bright anodized, satin chemical bright anodized and electrostatic powder painting options. While silver, yellow, inox, bronze and black anodized color coatings are available, it can also be painted to the desired RAL code with electrostatic powder painting.



IDEAL FOR ALL LIVING SPACES WITH MINIMAL, SLIM DESIGN. PRACTICAL CORNER SOLUTIONS



Product No	Height		Length		Surface
	mm	in	mm	ft	
LAT250080014MEGMS	83	3-1/4	2500	8 1/5"	MEGMS
LAT250080014R9005	83	3-1/4	2500	8 1/5"	R9005
LAT250080014R9016	83	3-1/4	2500	8 1/5"	R9016
LAT250080014R7016	83	3-1/4	2500	8 1/5"	R7016
LAT250100014MEGMS	100	3-15/16	2500	8 1/5"	MEGMS
LAT250100014R9005	100	3-15/16	2500	8 1/5"	R9005
LAT250100014R9016	100	3-15/16	2500	8 1/5"	R9016
LAT250100014R7016	100	3-15/16	2500	8 1/5"	R7016
LAT250120014MEGMS	120	4-3/4	2500	8 1/5"	MEGMS
LAT250120014R9005	120	4-3/4	2500	8 1/5"	R9005
LAT250120014R9016	120	4-3/4	2500	8 1/5"	R9016
LAT250120014R7016	120	4-3/4	2500	8 1/5"	R7016
LAT250150014MEGMS	150	5-7/8	2500	8 1/5"	MEGMS
LAT250150014R9005	150	5-7/8	2500	8 1/5"	R9005
LAT250150014R9016	150	5-7/8	2500	8 1/5"	R9016
LAT250150014R7016	150	5-7/8	2500	8 1/5"	R7016
LAT250180014MEGMS	180	7-1/16	2500	8 1/5"	MEGMS
LAT250180014R9005	180	7-1/16	2500	8 1/5"	R9005
LAT250180014R9016	180	7-1/16	2500	8 1/5"	R9016
LAT250180014R7016	180	7-1/16	2500	8 1/5"	R7016

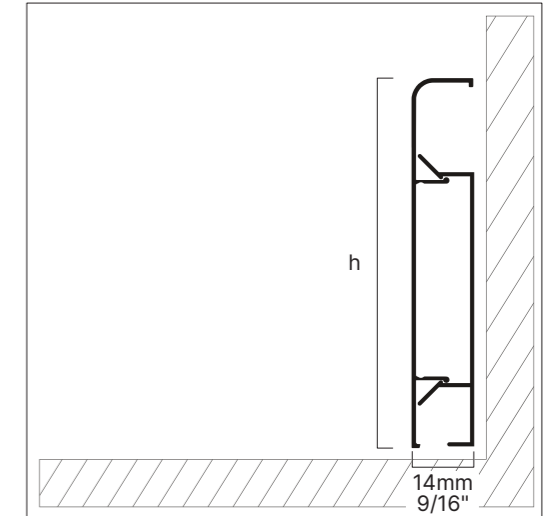

MEGMS matte silver, anodized	R9005 black, semi gloss, powder coated
R9016 white, semi gloss, powder coated	R7016 anthracite, semi gloss, powder coated

CORNER SOLUTIONS

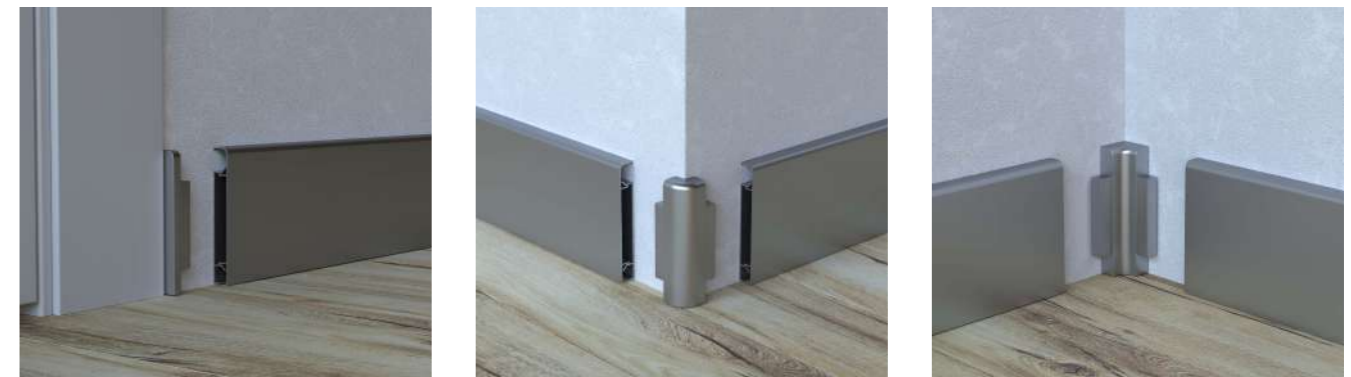

SOLE

Aluminum Skirting Board



Sole aluminum skirting board is mostly preferred in all living areas and public areas with classical design concepts. It covers the defects in floor and wall joints. It prevents dirt accumulation and harmful organisms to provide hygienic and healthy use for many years. With the hollow area in its design, it collects the telephone, electricity and internet cables to organize your environment. Sole is an eclipse series product. Aluminum products with eclipse marker have RAL7016 and RAL9016 color options.

DESIGNED FOR ALL CLASSICAL, LUXURIOUS AND PRESTIGIOUS LIVING SPACES



Product No	Height		Length		Surface
	mm	in	mm	ft	
SOL250100020MEGMS	100	3-15/16	2500	8 1/5"	MEGMS
SOL250100020R9005	100	3-15/16	2500	8 1/5"	R9005
SOL250100020R7016	100	3-15/16	2500	8 1/5"	R9016
SOL250100020R7016	100	3-15/16	2500	8 1/5"	R7016

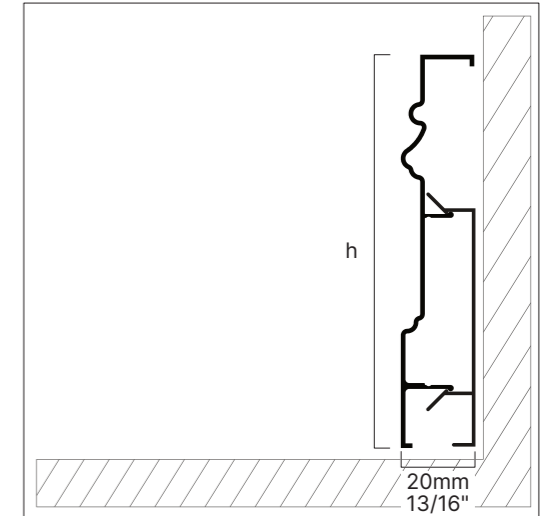

- 

MEGMS
matte silver, anodized
- 

R9005
black, semi gloss,
powder coated
- 

R9016
white, semi gloss,
powder coated
- 

R7016
anthracite, semi gloss,
powder coated

CORNER SOLUTIONS



CRISPO

Aluminum Skirting Board



Crispo aluminum skirting board is mostly preferred in areas with large gaps between wall and flooring due to its wide form. It covers the defects in floor and wall joints. It prevents dirt accumulation and harmful organisms to provide hygienic and healthy use for many years. With the hollow area in its design, it collects the telephone, electricity and internet cables to organize your environment. Crispo provides unity with its oval transition appearance and is compatible with both classical and modern architecture.

Crispo has matte anodized, bright anodized, satin chemical bright anodized and electrostatic powder painting options.

While silver, yellow, inox, bronze and black anodized color coatings are available, it can also be painted to the desired RAL code with electrostatic powder painting.

FOR AREAS WITH LARGE GAPS BETWEEN
WALL AND FLOORING



Product No	Height		Length		Surface
	mm	in	mm	ft	
CRS250070025MEGMS	70	2-3/4	2500	8 1/5"	MEGMS
CRS250070025R9005	70	2-3/4	2500	8 1/5"	R9005
CRS250070025R9016	70	2-3/4	2500	8 1/5"	R9016
CRS250070025R7016	70	2-3/4	2500	8 1/5"	R7016

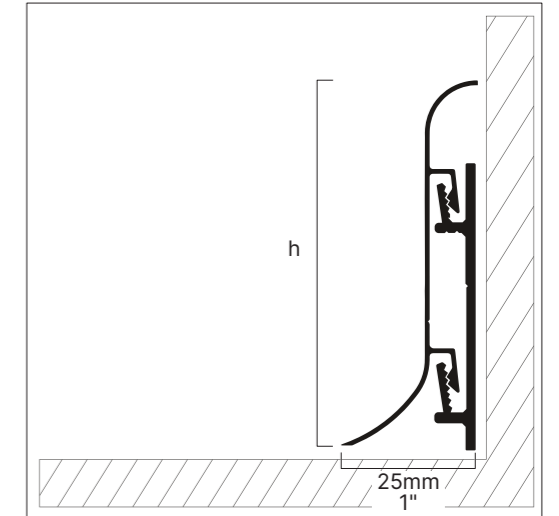

- 

MEGMS
matte silver, anodized
- 

R9005
black, semi gloss,
powder coated
- 

R9016
white, semi gloss,
powder coated
- 

R7016
anthracite, semi gloss,
powder coated

SENTIO

Aluminum Skirting Board



Sentio aluminum skirting board is mostly preferred in areas with large gaps between wall and flooring due to its wide form. With the extended hollow area in its design, it collects the telephone, electricity and internet cables to organize environments such as workplaces and offices. It covers the defects in floor and wall joints. It prevents dirt accumulation and harmful organisms to provide hygienic and healthy use for many years. Sentio has matte anodized, bright anodized, satin chemical bright anodized and electrostatic powder painting options. While silver, yellow, inox, bronze and black anodized color coatings are available, it can also be painted to the desired RAL code with electrostatic powder painting.

ORDER CABLES IN AREAS SUCH AS WORKPLACES AND PUT AN END TO THE MESS



Product No	Height		Length		Surface
	mm	in	mm	ft	
SNT250080023MEGMS	80	3-1/8	2500	8 1/5"	MEGMS
SNT250080023R9005	80	3-1/8	2500	8 1/5"	R9005
SNT250080023R9016	80	3-1/8	2500	8 1/5"	R9016
SNT250080023R7016	80	3-1/8	2500	8 1/5"	R7016

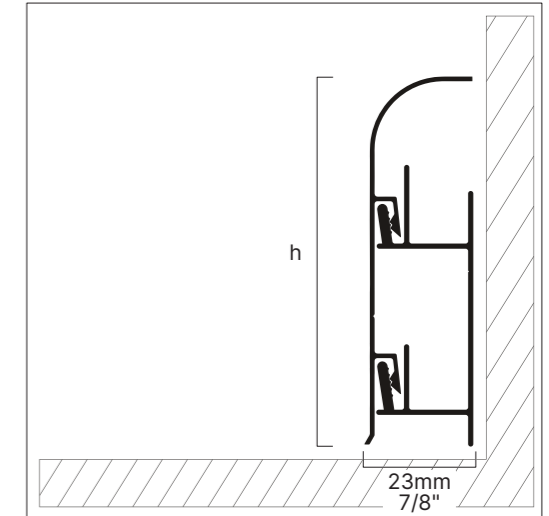
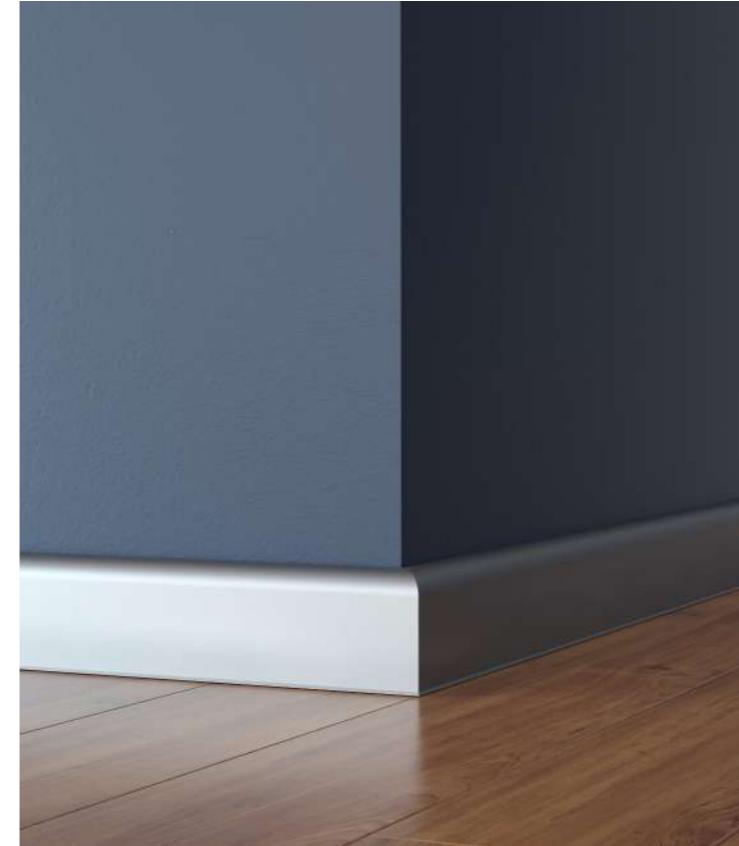

- 

MEGMS
matte silver, anodized
- 

R9005
black, semi gloss,
powder coated
- 

R9016
white, semi gloss,
powder coated
- 

R7016
anthracite, semi gloss,
powder coated

VELO

Aluminum Skirting Board



Velo aluminum skirting board provides skirting solutions especially for wet areas like bathrooms and kitchens. It takes up less space and offers ease of installation. It provides leak proofing as well as aesthetics by covering the wall-floor joint defects especially on wet areas. Velo has matte anodized, bright anodized, satin chemical bright anodized and electrostatic powder painting options. While silver, yellow, inox, bronze and black anodized color coatings are available, it can also be painted to the desired RAL code with electrostatic powder painting.

PROVIDES SEALING AND ELIMINATES JOINT DEFECTS TO FLOOR-WALL JOINTS IN WET AREAS



Product No	Height		Length		Surface
	mm	in	mm	ft	
VLO250060012MEGMS	60	2-3/8	2500	8 1/5"	MEGMS
VLO250060012R9005	60	2-3/8	2500	8 1/5"	R9005
VLO250060012R9016	60	2-3/8	2500	8 1/5"	R9016
VLO250060012R7016	60	2-3/8	2500	8 1/5"	R7016
VLO250100012MEGMS	100	3-15/16	2500	8 1/5"	MEGMS
VLO250100012R9005	100	3-15/16	2500	8 1/5"	R9005
VLO250100012R9016	100	3-15/16	2500	8 1/5"	R9016
VLO250100012R7016	100	3-15/16	2500	8 1/5"	R7016

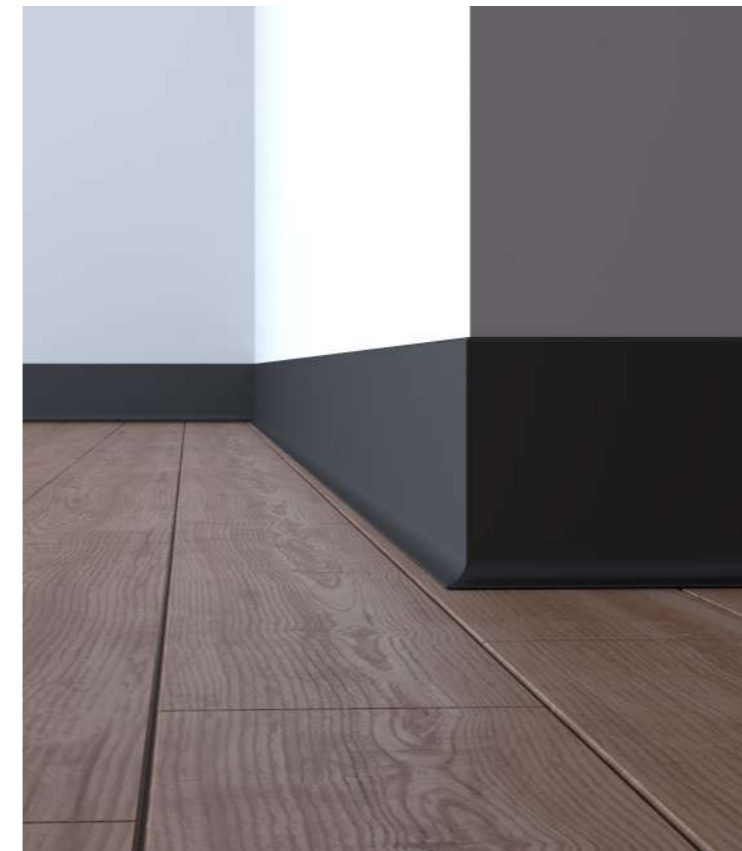
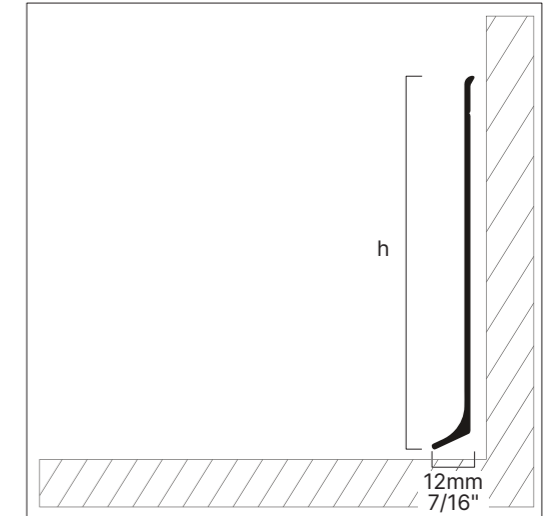

	
MEGMS matte silver, anodized	R9005 black, semi gloss, powder coated
	
R9016 white, semi gloss, powder coated	R7016 anthracite, semi gloss, powder coated

GRAVITY

Aluminum Skirting Board

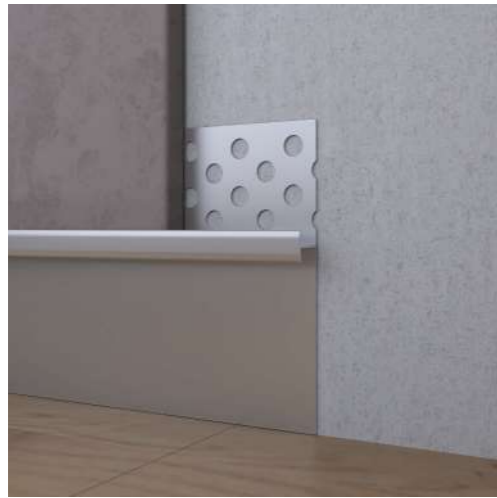

Gravity aluminum skirting board is a specially designed profile that is attached to the lower edges of the wall and provide a neat and clean appearance to carpeted areas. Gravity aluminum skirting board not only provides a seamless transition between the floor and the wall, but also provides protection for carpet edges.

Gravity aluminum skirting board has a matte anodized coating option in silver color.

COMPLEMENTARY ELEMENT OF YOUR INTERIOR DESIGNS



Product No	Height		Length		Surface
	mm	in	mm	ft	
GRV250100010MEGMS	100	3-15/16	2500	8 1/5"	MEGMS

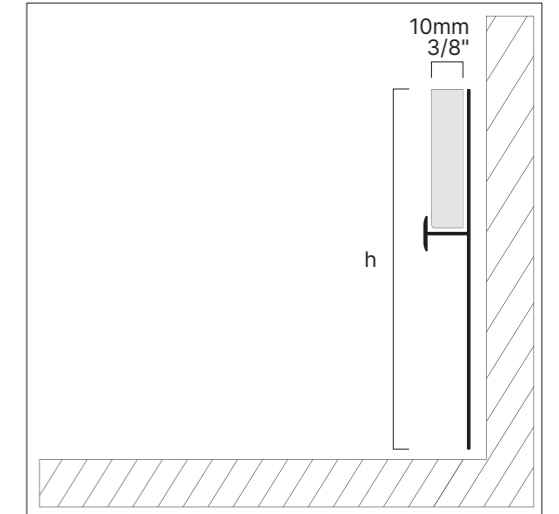

MEGMS
matte silver, anodized

MPS-F

Stainless Steel Skirting Board

MPS-F stainless steel skirting board profile is designed to provide skirting in ceramic applications. It prevents moisture in the application areas and reduces the transmission of impact sound. Gives an aesthetic appearance by hiding application defects in floor and wall transitions. It is extremely durable, long-lasting and corrosion resistant since it is produced from 304L quality stainless steel. 201 quality stainless steel alternative also available. MPS-F provides a flush appearance with its joint extension. MPS-F has mirror, satin, exclusive super mirror surfaces and anthracite, bronze, copper, gold, inox color options. MPS-F can be produced in unlimited height and width options.



PREVENTS MOISTURE PENETRATION TO JOINTS AND REDUCES SOUND TRANSMISSION IN THE IMPACT ZONE



Product No	Height		Length		Surface
	mm	in	mm	ft	
MPF2430400XXSTANT	40	1-9/16	2438	8	STANT
MPF2430400XXMRANT	40	1-9/16	2438	8	MRANT
MPF2430400XXSTBRO	40	1-9/16	2438	8	STBRO
MPF2430400XXMRBRO	40	1-9/16	2438	8	MRBRO
MPF2430400XXSTCOP	40	1-9/16	2438	8	STCOP
MPF2430400XXMRCOP	40	1-9/16	2438	8	MRCOP
MPF2430400XXSTGLD	40	1-9/16	2438	8	STGLD
MPF2430400XXMRGLD	40	1-9/16	2438	8	MRGLD
MPF2500400XXSTINX	40	1-9/16	2500	8 1/5"	STINX
MPF2500400XXMRINX	40	1-9/16	2500	8 1/5"	MRINX
MPF2430400XXSMINX	40	1-9/16	2438	8	SMINX
MPF2430600XXSTANT	70	2-3/4	2438	8	STANT
MPF2430600XXMRANT	70	2-3/4	2438	8	MRANT
MPF2430600XXSTBRO	70	2-3/4	2438	8	STBRO
MPF2430600XXMRBRO	70	2-3/4	2438	8	MRBRO
MPF2430600XXSTCOP	70	2-3/4	2438	8	STCOP
MPF2430600XXMRCOP	70	2-3/4	2438	8	MRCOP
MPF2430600XXSTGLD	70	2-3/4	2438	8	STGLD
MPF2430600XXMRGLD	70	2-3/4	2438	8	MRGLD
MPF2500600XXSTINX	70	2-3/4	2500	8 1/5"	STINX
MPF2500600XXMRINX	70	2-3/4	2500	8 1/5"	MRINX
MPF2430600XXSMINX	70	2-3/4	2438	8	SMINX

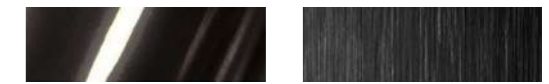
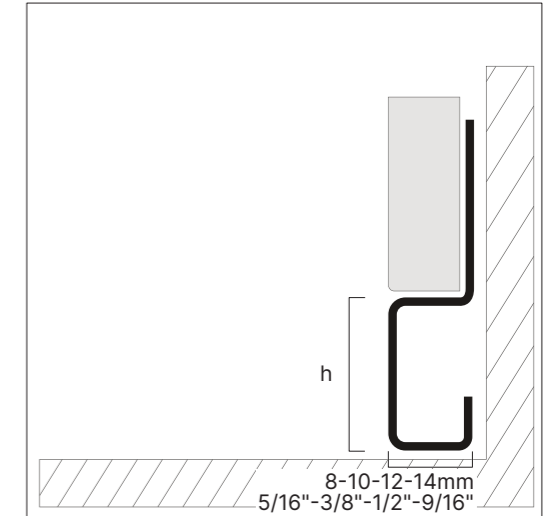

MRANT anthracite mirror

STANT anthracite satin



MRBRO bronze mirror

STBRO bronze satin



MRCOP copper mirror

STCOP copper satin



MRGLD gold mirror

STGLD gold satin





MRINX inox mirror

STINX inox satin



SMINX super mirror

 Stainless steel products can be produced in any requested height (h).

 Lengths (L) may vary according to surface options of stainless steel products.

CERAMIC BORDERS, TILE TRIM PROFILES
CERAMIC PROTECTION PROFILES

Mox tile trim profiles will eliminate joint and application flaws and prevent damage to ceramics while providing aesthetics to your living spaces. They prevent deformations in applied areas by preventing any leakage.

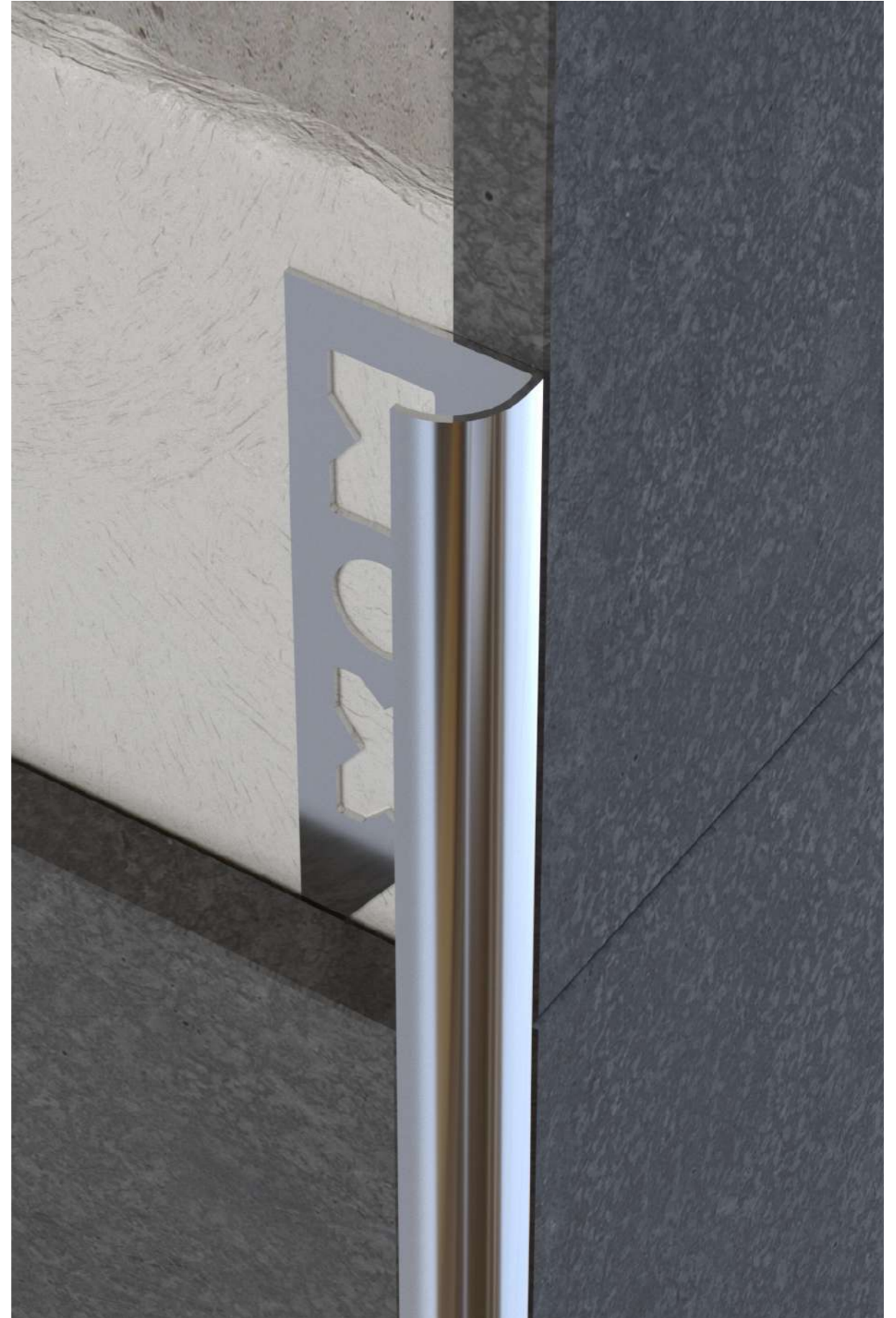

MONO-FIX

Aluminum Tile Trim



Mono Fix aluminium tile trim edge adds aesthetics to your ceramic applications with its wide range of surface options compatible with trending ceramic colors and textures. It is used as a frame that conceals the ceramic section at the ends of ceramic wall applications or as parquet joints. While providing aesthetics that will eliminate joint and application flaws, it also prevents ceramics from taking damage.

Mono Fix has matte anodized, bright anodized and electrostatic powder painting options. While silver, yellow, inox and black anodized color coatings are available, it can also be painted to the desired RAL code with electrostatic powder painting.

CERAMIC PROTECTION WITH AN ELEGANT APPEARANCE



Product No	Height		Length		Surface
	mm	in	mm	ft	
MNF250010003MEGMS	10	3/8	2500	8 1/5"	MEGMS
MNF250010003MESAR	10	3/8	2500	8 1/5"	MESAR
MNF250010003MEINX	10	3/8	2500	8 1/5"	MEINX
MNF250010003MESYH	10	3/8	2500	8 1/5"	MESYH
MNF250010003PEGMS	10	3/8	2500	8 1/5"	PEGMS
MNF250010003PESAR	10	3/8	2500	8 1/5"	PESAR
MNF250010003PEINX	10	3/8	2500	8 1/5"	PEINX
MNF250010003PESYH	10	3/8	2500	8 1/5"	PESYH
MNF250010003R9016	10	3/8	2500	8 1/5"	R9016
MNF250010003R7016	10	3/8	2500	8 1/5"	R7016

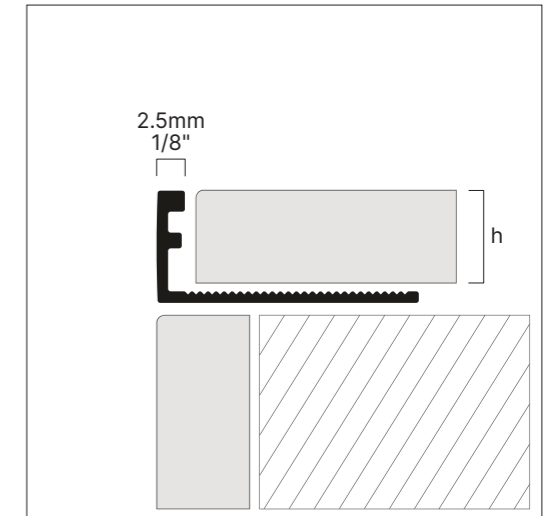

MEGMS matte silver, anodized	MESAR matte yellow, anodized
MEINX matte inox, anodized	MESYH matte black, anodized
PEGMS bright silver, anodized	PESAR bright yellow, anodized
PEINX bright inox, anodized	PESYH bright black, anodized
R9016 white, semi gloss, powder coated	R7016 anthracite, semi gloss, powder coated

ROUND-FIX

Aluminum Tile Trim

Round Fix aluminium tile trim round external corner adds aesthetics to your ceramic applications with its wide range of surface options compatible with trending ceramic colors and textures. It is used in 90 degrees outer corner joints of ceramic applications. In addition to providing aesthetics that will eliminate joint and application flaws, it also prevents damage to ceramics.

Round Fix has matte anodized, bright anodized electrostatic powder painting options. While silver, yellow, inox and black anodized color coatings are available, it can also be painted to the desired RAL code with electrostatic powder painting.



ELEVATE YOUR CERAMIC APPLICATIONS:
SEAMLESS STYLE, UNMATCHED PROTECTION



Product No	Height		Length		Surface
	mm	in	mm	ft	
RNF250010009MEGMS	10	3/8	2500	8 1/5"	MEGMS
RNF250010009MESAR	10	3/8	2500	8 1/5"	MESAR
RNF250010009MEINX	10	3/8	2500	8 1/5"	MEINX
RNF250010009MESYH	10	3/8	2500	8 1/5"	MESYH
RNF250010009PEGMS	10	3/8	2500	8 1/5"	PEGMS
RNF250010009PESAR	10	3/8	2500	8 1/5"	PESAR
RNF250010009PEINX	10	3/8	2500	8 1/5"	PEINX
RNF250010009PESYH	10	3/8	2500	8 1/5"	PESYH
RNF250010009R9016	10	3/8	2500	8 1/5"	R9016
RNF250010009R7016	10	3/8	2500	8 1/5"	R7016

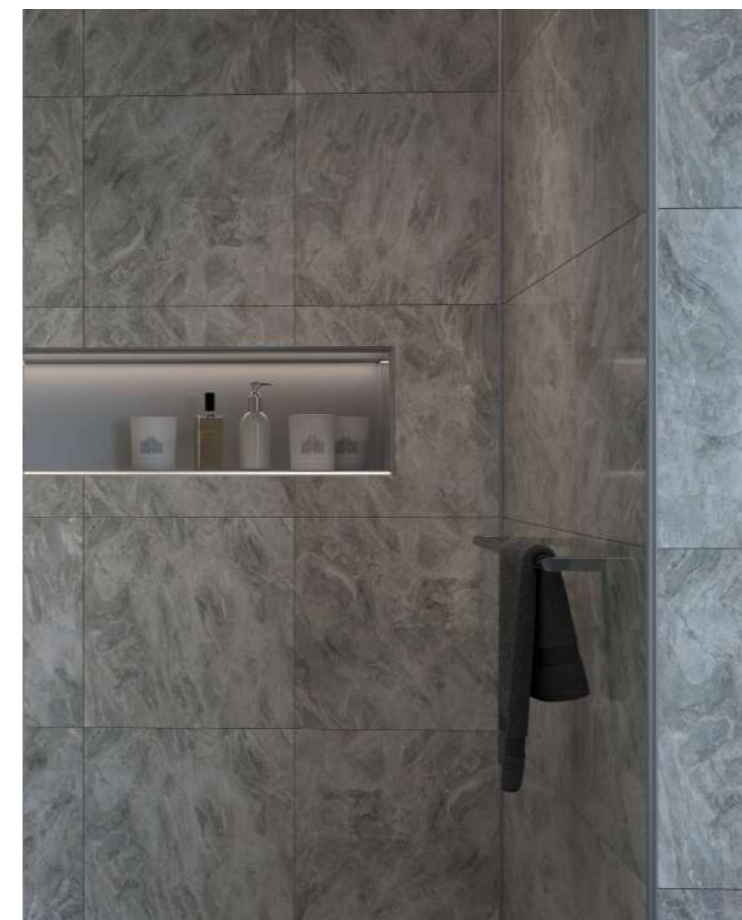
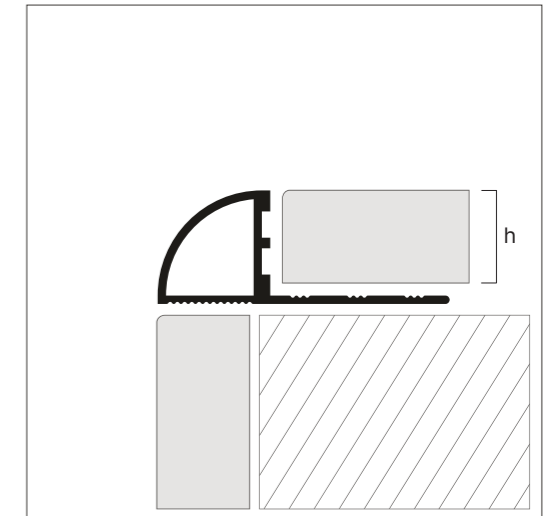

MEGMS matte silver, anodized	MESAR matte yellow, anodized
MEINX matte inox, anodized	MESYH matte black, anodized
PEGMS bright silver, anodized	PESAR bright yellow, anodized
PEINX bright inox, anodized	PESYH bright black, anodized
R9016 white, semi gloss, powder coated	R7016 anthracite, semi gloss, powder coated

SQUARE-FIX

Aluminum Tile Trim



Square Fix aluminium tile trim square external corner adds aesthetics to your ceramic applications with its wide range of surface options compatible with trending ceramic colors and textures. It is used in 90 degrees outer corner joints of ceramic applications. In addition to providing aesthetics that will eliminate joint and application flaws, it also prevents damage to ceramics.

Square Fix has matte anodized, bright anodized and electrostatic powder painting options. While silver, yellow, inox and black anodized color coatings are available, it can also be painted to the desired RAL code with electrostatic powder painting.

FLAWLESS APPEARANCE ON CERAMIC SURFACES,
WIDE RANGE OF COLOR AND EFFECT OPTIONS TO
ADAPT TRENDING CERAMIC COLORS AND TEXTURES



Product No	Height		Length		Surface
	mm	in	mm	ft	
SQF250010009MEGMS	10	3/8	2500	8 1/5"	MEGMS
SQF250010009MESAR	10	3/8	2500	8 1/5"	MESAR
SQF250010009MEINX	10	3/8	2500	8 1/5"	MEINX
SQF250010009MESYH	10	3/8	2500	8 1/5"	MESYH
SQF250010009PEGMS	10	3/8	2500	8 1/5"	PEGMS
SQF250010009PESAR	10	3/8	2500	8 1/5"	PESAR
SQF250010009PEINX	10	3/8	2500	8 1/5"	PEINX
SQF250010009PESYH	10	3/8	2500	8 1/5"	PESYH
SQF250010009R9016	10	3/8	2500	8 1/5"	R9016
SQF250010009R7016	10	3/8	2500	8 1/5"	R7016

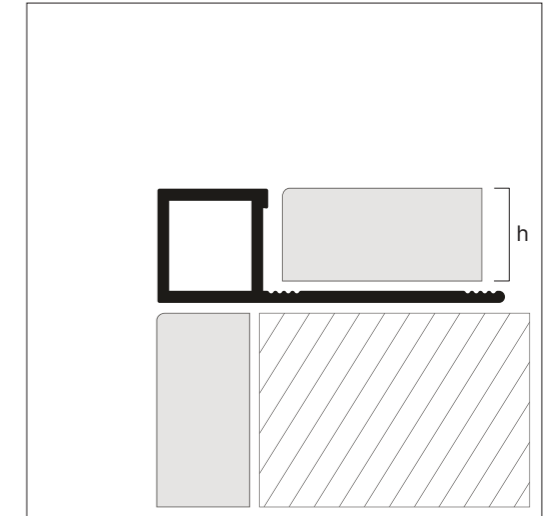

MEGMS matte silver, anodized	MESAR matte yellow, anodized
MEINX matte inox, anodized	MESYH matte black, anodized
PEGMS bright silver, anodized	PESAR bright yellow, anodized
PEINX bright inox, anodized	PESYH bright black, anodized
R9016 white, semi gloss, powder coated	R7016 anthracite, semi gloss, powder coated

MPS-AG

Stainless Steel Tile Trim

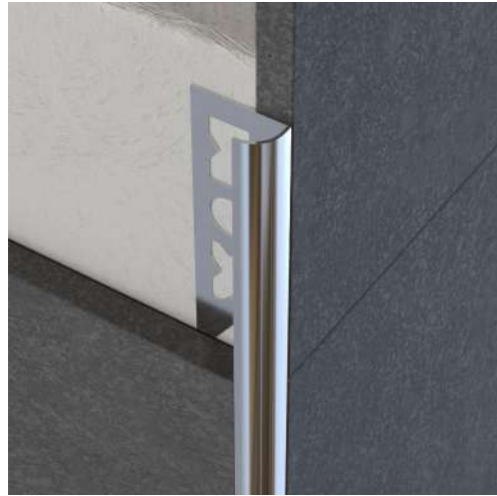

MPS-AG stainless steel tile trim round external corner profile stands out with its ceramic protection feature and elegant appearance, especially in bathrooms and kitchens with ceramic surfaces. It is used in 90 degrees outer corner joints of ceramic applications. In addition to providing aesthetics that will eliminate joint and application flaws, it also prevents damage to ceramics. MPS-AG has mirror, satin, exclusive super mirror surfaces and anthracite, bronze, copper, gold, inox color options. MPS-AG can be produced in unlimited height and width options.

AN ELEGANT APPEARANCE THAT SOFTENS THE TRANSITION OF THE OUTER CORNERS



Product No	Height		Length		Surface
	mm	in	mm	ft	
MAG243010008STANT	8	5/16	2438	8	STANT
MAG243010008MRANT	8	5/16	2438	8	MRANT
MAG243010008STBRO	8	5/16	2438	8	STBRO
MAG243010008MRBRO	8	5/16	2438	8	MRBRO
MAG243010008STCOP	8	5/16	2438	8	STCOP
MAG243010008MRCOP	8	5/16	2438	8	MRCOP
MAG243010008STGLD	8	5/16	2438	8	STGLD
MAG243010008MRGLD	8	5/16	2438	8	MRGLD
MAG250010008STINX	8	5/16	2500	8 1/5"	STINX
MAG250010008MRINX	8	5/16	2500	8 1/5"	MRINX
MAG243010008SMINX	8	5/16	2438	8	SMINX
MAG243012008STANT	10	3/8	2438	8	STANT
MAG243012008MRANT	10	3/8	2438	8	MRANT
MAG243012008STBRO	10	3/8	2438	8	STBRO
MAG243012008MRBRO	10	3/8	2438	8	MRBRO
MAG243012008STCOP	10	3/8	2438	8	STCOP
MAG243012008MRCOP	10	3/8	2438	8	MRCOP
MAG243012008STGLD	10	3/8	2438	8	STGLD
MAG243012008MRGLD	10	3/8	2438	8	MRGLD
MAG250012008STINX	10	3/8	2500	8 1/5"	STINX
MAG250012008MRINX	10	3/8	2500	8 1/5"	MRINX
MAG243012008SMINX	10	3/8	2438	8	SMINX
MAG243014008STANT	12	1/2	2438	8	STANT
MAG243014008MRANT	12	1/2	2438	8	MRANT
MAG243014008STBRO	12	1/2	2438	8	STBRO
MAG243014008MRBRO	12	1/2	2438	8	MRBRO
MAG243014008STCOP	12	1/2	2438	8	STCOP
MAG243014008MRCOP	12	1/2	2438	8	MRCOP
MAG243014008STGLD	12	1/2	2438	8	STGLD
MAG243014008MRGLD	12	1/2	2438	8	MRGLD
MAG250014008STINX	12	1/2	2500	8 1/5"	STINX
MAG250014008MRINX	12	1/2	2500	8 1/5"	MRINX
MAG243014008SMINX	12	1/2	2438	8	SMINX
MAG243010008STANT	14	9/16	2438	8	STANT
MAG243010008MRANT	14	9/16	2438	8	MRANT
MAG243010008STBRO	14	9/16	2438	8	STBRO
MAG243010008MRBRO	14	9/16	2438	8	MRBRO
MAG243010008STCOP	14	9/16	2438	8	STCOP
MAG243010008MRCOP	14	9/16	2438	8	MRCOP
MAG243010008STGLD	14	9/16	2438	8	STGLD
MAG243010008MRGLD	14	9/16	2438	8	MRGLD
MAG250010008STINX	14	9/16	2500	8 1/5"	STINX
MAG250010008MRINX	14	9/16	2500	8 1/5"	MRINX
MAG243010008SMINX	14	9/16	2438	8	SMINX

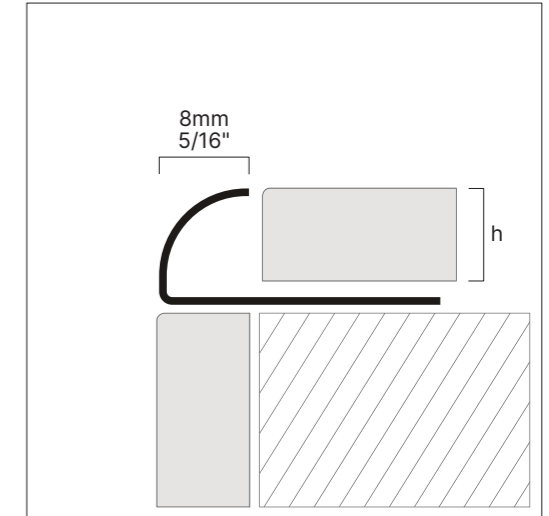

MRANT anthracite mirror

STANT anthracite satin



MRBRO bronze mirror

STBRO bronze satin



MRCOP copper mirror

STCOP copper satin



MRGLD gold mirror

STGLD gold satin





MRINX inox mirror

STINX inox satin



SMINX super mirror

 Stainless steel products can be produced in any requested height (h).

 Lengths (L) may vary according to surface options of stainless steel products.

MPS-BRD

Stainless Steel Border



MPS-BRD stainless steel tile trim border is mostly used as a decorative divider for ceramics. Being compatible with other tile trim profiles is one of its advantages. MPS-BRD has mirror, satin, exclusive super mirror surfaces and anthracite, bronze, copper, gold, inox color options. MPS-BRD can be produced in unlimited height and width options.

DECORATIVE BORDER PROFILE FOR CERAMIC SURFACES



Product No	Height		Length		Surface
	mm	in	mm	ft	
MBD2430XX023STANT	8	5/16	2438	8	STANT
MBD2430XX023MRANT	8	5/16	2438	8	MRANT
MBD2430XX023STBRO	8	5/16	2438	8	STBRO
MBD2430XX023MRBRO	8	5/16	2438	8	MRBRO
MBD2430XX023STCOP	8	5/16	2438	8	STCOP
MBD2430XX023MRCOP	8	5/16	2438	8	MRCOP
MBD2430XX023STGLD	8	5/16	2438	8	STGLD
MBD2430XX023MRGLD	8	5/16	2438	8	MRGLD
MBD2500XX023STINX	8	5/16	2500	8 1/5"	STINX
MBD2500XX023MRINX	8	5/16	2500	8 1/5"	MRINX
MBD2430XX023SMINX	8	5/16	2438	8	SMINX
MBD2430XX010STANT	10	3/8	2438	8	STANT
MBD2430XX010MRANT	10	3/8	2438	8	MRANT
MBD2430XX010STBRO	10	3/8	2438	8	STBRO
MBD2430XX010MRBRO	10	3/8	2438	8	MRBRO
MBD2430XX010STCOP	10	3/8	2438	8	STCOP
MBD2430XX010MRCOP	10	3/8	2438	8	MRCOP
MBD2430XX010STGLD	10	3/8	2438	8	STGLD
MBD2430XX010MRGLD	10	3/8	2438	8	MRGLD
MBD2500XX010STINX	10	3/8	2500	8 1/5"	STINX
MBD2500XX010MRINX	10	3/8	2500	8 1/5"	MRINX
MBD2430XX010SMINX	10	3/8	2438	8	SMINX
MBD2430XX015STANT	12	1/2	2438	8	STANT
MBD2430XX015MRANT	12	1/2	2438	8	MRANT
MBD2430XX015STBRO	12	1/2	2438	8	STBRO
MBD2430XX015MRBRO	12	1/2	2438	8	MRBRO
MBD2430XX015STCOP	12	1/2	2438	8	STCOP
MBD2430XX015MRCOP	12	1/2	2438	8	MRCOP
MBD2430XX015STGLD	12	1/2	2438	8	STGLD
MBD2430XX015MRGLD	12	1/2	2438	8	MRGLD
MBD2500XX015STINX	12	1/2	2500	8 1/5"	STINX
MBD2500XX015MRINX	12	1/2	2500	8 1/5"	MRINX
MBD2430XX015SMINX	12	1/2	2438	8	SMINX
MBD2430XX020STANT	14	9/16	2438	8	STANT
MBD2430XX020MRANT	14	9/16	2438	8	MRANT
MBD2430XX020STBRO	14	9/16	2438	8	STBRO
MBD2430XX020MRBRO	14	9/16	2438	8	MRBRO
MBD2430XX020STCOP	14	9/16	2438	8	STCOP
MBD2430XX020MRCOP	14	9/16	2438	8	MRCOP
MBD2430XX020STGLD	14	9/16	2438	8	STGLD
MBD2430XX020MRGLD	14	9/16	2438	8	MRGLD
MBD2500XX020STINX	14	9/16	2500	8 1/5"	STINX
MBD2500XX020MRINX	14	9/16	2500	8 1/5"	MRINX
MBD2430XX020SMINX	14	9/16	2438	8	SMINX

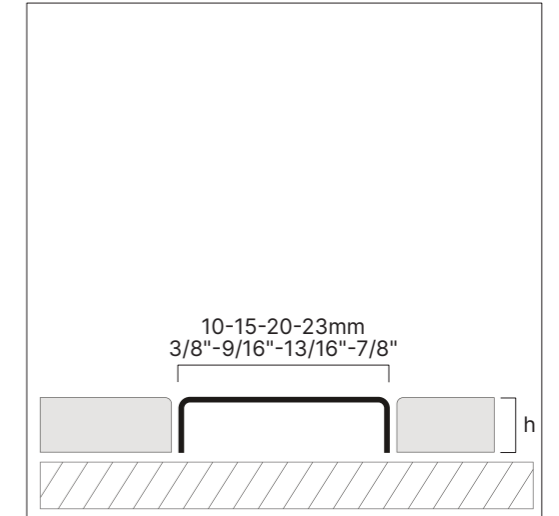

MRANT anthracite mirror

STANT anthracite satin



MRBRO bronze mirror

STBRO bronze satin



MRCOP copper mirror

STCOP copper satin



MRGLD gold mirror

STGLD gold satin



MRINX inox mirror

STINX inox satin



SMINX super mirror

 Stainless steel products can be produced in any requested height (h).

 Lengths (L) may vary according to surface options of stainless steel products.

MPS-C

Stainless Steel Tile Trim



MPS-C stainless steel tile trim internal corner profile adapts to trend ceramic colors and textures while adding aesthetics to your ceramic applications with its wide range of surface options. It is used in 90 degrees inner corner joints of ceramic applications. In addition to providing aesthetics that will eliminate joint and application flaws, it also prevents damage to ceramics. MPS-C has mirror, satin, exclusive super mirror surfaces and anthracite, bronze, copper, gold, inox color options. MPS-C can be produced in unlimited height and width options.

QUALITY OF STAINLESS STEEL FOR INNER CORNERS OF CERAMIC APPLICATIONS



Product No	Height		Length		Surface
	mm	in	mm	ft	
MPC243010009STANT	8	5/16	2438	8	STANT
MPC243010009MRANT	8	5/16	2438	8	MRANT
MPC243010009STBRO	8	5/16	2438	8	STBRO
MPC243010009MRBRO	8	5/16	2438	8	MRBRO
MPC243010009STCOP	8	5/16	2438	8	STCOP
MPC243010009MRCOP	8	5/16	2438	8	MRCOP
MPC243010009STGLD	8	5/16	2438	8	STGLD
MPC243010009MRGLD	8	5/16	2438	8	MRGLD
MPC250010009STINX	8	5/16	2500	8 1/5"	STINX
MPC250010009MRINX	8	5/16	2500	8 1/5"	MRINX
MPC243010009SMINX	8	5/16	2438	8	SMINX
MPC243012009STANT	10	3/8	2438	8	STANT
MPC243012009MRANT	10	3/8	2438	8	MRANT
MPC243012009STBRO	10	3/8	2438	8	STBRO
MPC243012009MRBRO	10	3/8	2438	8	MRBRO
MPC243012009STCOP	10	3/8	2438	8	STCOP
MPC243012009MRCOP	10	3/8	2438	8	MRCOP
MPC243012009STGLD	10	3/8	2438	8	STGLD
MPC243012009MRGLD	10	3/8	2438	8	MRGLD
MPC250012009STINX	10	3/8	2500	8 1/5"	STINX
MPC250012009MRINX	10	3/8	2500	8 1/5"	MRINX
MPC243012009SMINX	10	3/8	2438	8	SMINX
MPC243014009STANT	12	1/2	2438	8	STANT
MPC243014009MRANT	12	1/2	2438	8	MRANT
MPC243014009STBRO	12	1/2	2438	8	STBRO
MPC243014009MRBRO	12	1/2	2438	8	MRBRO
MPC243014009STCOP	12	1/2	2438	8	STCOP
MPC243014009MRCOP	12	1/2	2438	8	MRCOP
MPC243014009STGLD	12	1/2	2438	8	STGLD
MPC243014009MRGLD	12	1/2	2438	8	MRGLD
MPC250014009STINX	12	1/2	2500	8 1/5"	STINX
MPC250014009MRINX	12	1/2	2500	8 1/5"	MRINX
MPC243014009SMINX	12	1/2	2438	8	SMINX
MPC243008009STANT	14	9/16	2438	8	STANT
MPC243008009MRANT	14	9/16	2438	8	MRANT
MPC243008009STBRO	14	9/16	2438	8	STBRO
MPC243008009MRBRO	14	9/16	2438	8	MRBRO
MPC243008009STCOP	14	9/16	2438	8	STCOP
MPC243008009MRCOP	14	9/16	2438	8	MRCOP
MPC243008009STGLD	14	9/16	2438	8	STGLD
MPC243008009MRGLD	14	9/16	2438	8	MRGLD
MPC250008009STINX	14	9/16	2500	8 1/5"	STINX
MPC250008009MRINX	14	9/16	2500	8 1/5"	MRINX
MPC243008009SMINX	14	9/16	2438	8	SMINX

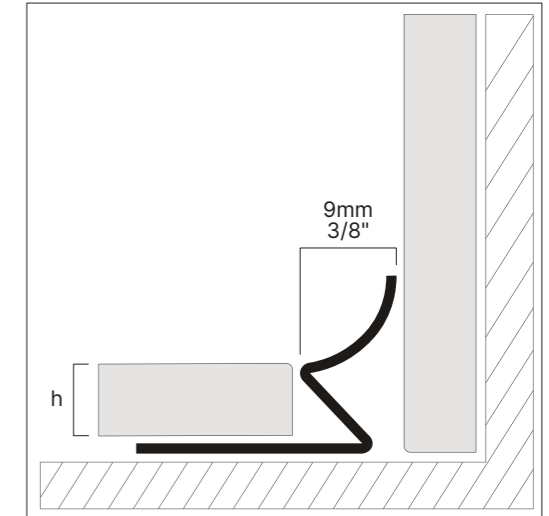

MRANT anthracite mirror

STANT anthracite satin



MRBRO bronze mirror

STBRO bronze satin



MRCOP copper mirror

STCOP copper satin



MRGLD gold mirror

STGLD gold satin



MRINX inox mirror

STINX inox satin



SMINX super mirror

 Stainless steel products can be produced in any requested height (h).

 Lengths (L) may vary according to surface options of stainless steel products.

MPS-D

Stainless Steel Tile Trim



MPS-D stainless steel tile trim square external corner profile adapts to trend ceramic colors and textures while adding aesthetics to your ceramic applications with its wide range of surface options. It is used in 90 degrees outer corner joints of ceramic applications. In addition to providing aesthetics that will eliminate joint and application flaws, it also prevents damage to ceramics. MPS-D has mirror, satin, exclusive super mirror surfaces and anthracite, bronze, copper, gold, inox color options. MPS-D can be produced in unlimited height and width options.

PROVIDES PERFECT APPEARANCE TO CERAMIC SURFACES AND PREVENTS DAMAGE TO CERAMICS WITH THE QUALITY OF STAINLESS STEEL



Product No	Height		Length		Surface
	mm	in	mm	ft	
MPD243014008STANT	8	5/16	2438	8	STANT
MPD243014008MRANT	8	5/16	2438	8	MRANT
MPD243014008STBRO	8	5/16	2438	8	STBRO
MPD243014008MRBRO	8	5/16	2438	8	MRBRO
MPD243014008STCOP	8	5/16	2438	8	STCOP
MPD243014008MRCOP	8	5/16	2438	8	MRCOP
MPD243014008STGLD	8	5/16	2438	8	STGLD
MPD243014008MRGLD	8	5/16	2438	8	MRGLD
MPD250014008STINX	8	5/16	2500	8 1/5"	STINX
MPD250014008MRINX	8	5/16	2500	8 1/5"	MRINX
MPD243014008SMINX	8	5/16	2438	8	SMINX
MPD243008008STANT	10	3/8	2438	8	STANT
MPD243008008MRANT	10	3/8	2438	8	MRANT
MPD243008008STBRO	10	3/8	2438	8	STBRO
MPD243008008MRBRO	10	3/8	2438	8	MRBRO
MPD243008008STCOP	10	3/8	2438	8	STCOP
MPD243008008MRCOP	10	3/8	2438	8	MRCOP
MPD243008008STGLD	10	3/8	2438	8	STGLD
MPD243008008MRGLD	10	3/8	2438	8	MRGLD
MPD250008008STINX	10	3/8	2500	8 1/5"	STINX
MPD250008008MRINX	10	3/8	2500	8 1/5"	MRINX
MPD243008008SMINX	10	3/8	2438	8	SMINX
MPD243010008STANT	12	1/2	2438	8	STANT
MPD243010008MRANT	12	1/2	2438	8	MRANT
MPD243010008STBRO	12	1/2	2438	8	STBRO
MPD243010008MRBRO	12	1/2	2438	8	MRBRO
MPD243010008STCOP	12	1/2	2438	8	STCOP
MPD243010008MRCOP	12	1/2	2438	8	MRCOP
MPD243010008STGLD	12	1/2	2438	8	STGLD
MPD243010008MRGLD	12	1/2	2438	8	MRGLD
MPD250010008STINX	12	1/2	2500	8 1/5"	STINX
MPD250010008MRINX	12	1/2	2500	8 1/5"	MRINX
MPD243010008SMINX	12	1/2	2438	8	SMINX
MPD243012008STANT	14	9/16	2438	8	STANT
MPD243012008MRANT	14	9/16	2438	8	MRANT
MPD243012008STBRO	14	9/16	2438	8	STBRO
MPD243012008MRBRO	14	9/16	2438	8	MRBRO
MPD243012008STCOP	14	9/16	2438	8	STCOP
MPD243012008MRCOP	14	9/16	2438	8	MRCOP
MPD243012008STGLD	14	9/16	2438	8	STGLD
MPD243012008MRGLD	14	9/16	2438	8	MRGLD
MPD250012008STINX	14	9/16	2500	8 1/5"	STINX
MPD250012008MRINX	14	9/16	2500	8 1/5"	MRINX
MPD243012008SMINX	14	9/16	2438	8	SMINX

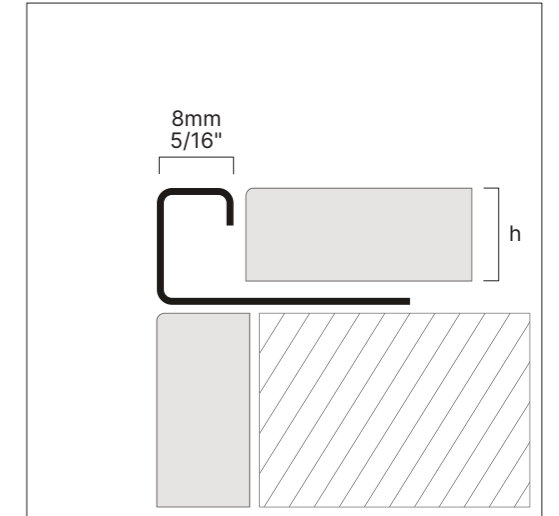

MRANT anthracite mirror

STANT anthracite satin



MRBRO bronze mirror

STBRO bronze satin



MRCOP copper mirror

STCOP copper satin



MRGLD gold mirror

STGLD gold satin



MRINX inox mirror

STINX inox satin



SMINX super mirror

 Stainless steel products can be produced in any requested height (h).

 Lengths (L) may vary according to surface options of stainless steel products.

MPS-L

Stainless Steel Tile Trim



MPS-L stainless steel tile trim edge profile adapts to trend ceramic colors and textures while adding aesthetics to your ceramic applications with its wide range of surface options. It is used as a frame that conceals the ceramic section at the ends of ceramic wall applications or as parquet joints. While providing aesthetics that will eliminate joint and application flaws, it also prevents ceramics from taking damage. MPS-L has mirror, satin, exclusive super mirror surfaces and anthracite, bronze, copper, gold, inox color options. MPS-L can be produced in unlimited height and width options.

PURE AND MINIMAL APPEARANCE TO CERAMIC COMBINATIONS WITH ITS SIMPLE DESIGN



Product No	Height		Length		Surface
	mm	in	mm	ft	
MPL243010003STANT	8	5/16	2438	8	STANT
MPL243010003MRANT	8	5/16	2438	8	MRANT
MPL243010003STBRO	8	5/16	2438	8	STBRO
MPL243010003MRBRO	8	5/16	2438	8	MRBRO
MPL243010003STCOP	8	5/16	2438	8	STCOP
MPL243010003MRCOP	8	5/16	2438	8	MRCOP
MPL243010003STGLD	8	5/16	2438	8	STGLD
MPL243010003MRGLD	8	5/16	2438	8	MRGLD
MPL250010003STINX	8	5/16	2500	8 1/5"	STINX
MPL250010003MRINX	8	5/16	2500	8 1/5"	MRINX
MPL243010003SMINX	8	5/16	2438	8	SMINX
MPL243012003STANT	10	3/8	2438	8	STANT
MPL243012003MRANT	10	3/8	2438	8	MRANT
MPL243012003STBRO	10	3/8	2438	8	STBRO
MPL243012003MRBRO	10	3/8	2438	8	MRBRO
MPL243012003STCOP	10	3/8	2438	8	STCOP
MPL243012003MRCOP	10	3/8	2438	8	MRCOP
MPL243012003STGLD	10	3/8	2438	8	STGLD
MPL243012003MRGLD	10	3/8	2438	8	MRGLD
MPL250012003STINX	10	3/8	2500	8 1/5"	STINX
MPL250012003MRINX	10	3/8	2500	8 1/5"	MRINX
MPL243012003SMINX	10	3/8	2438	8	SMINX
MPL243014003STANT	12	1/2	2438	8	STANT
MPL243014003MRANT	12	1/2	2438	8	MRANT
MPL243014003STBRO	12	1/2	2438	8	STBRO
MPL243014003MRBRO	12	1/2	2438	8	MRBRO
MPL243014003STCOP	12	1/2	2438	8	STCOP
MPL243014003MRCOP	12	1/2	2438	8	MRCOP
MPL243014003STGLD	12	1/2	2438	8	STGLD
MPL243014003MRGLD	12	1/2	2438	8	MRGLD
MPL250014003STINX	12	1/2	2500	8 1/5"	STINX
MPL250014003MRINX	12	1/2	2500	8 1/5"	MRINX
MPL243014003SMINX	12	1/2	2438	8	SMINX
MPL243008003STANT	14	9/16	2438	8	STANT
MPL243008003MRANT	14	9/16	2438	8	MRANT
MPL243008003STBRO	14	9/16	2438	8	STBRO
MPL243008003MRBRO	14	9/16	2438	8	MRBRO
MPL243008003STCOP	14	9/16	2438	8	STCOP
MPL243008003MRCOP	14	9/16	2438	8	MRCOP
MPL243008003STGLD	14	9/16	2438	8	STGLD
MPL243008003MRGLD	14	9/16	2438	8	MRGLD
MPL250008003STINX	14	9/16	2500	8 1/5"	STINX
MPL250008003MRINX	14	9/16	2500	8 1/5"	MRINX
MPL243008003SMINX	14	9/16	2438	8	SMINX

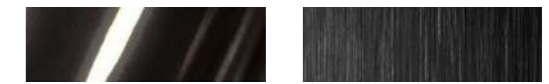
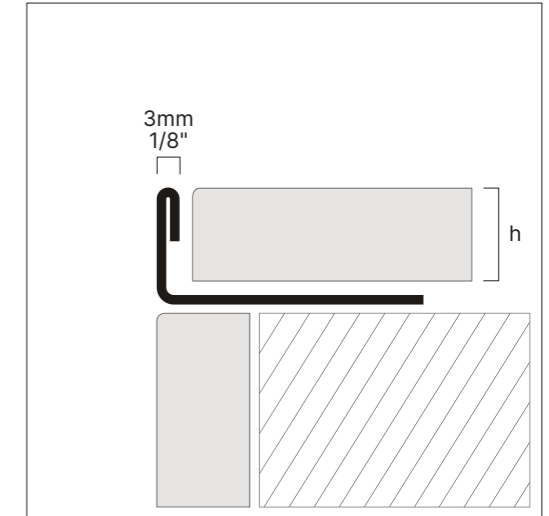

MRANT anthracite mirror

STANT anthracite satin



MRBRO bronze mirror

STBRO bronze satin



MRCOP copper mirror

STCOP copper satin



MRGLD gold mirror

STGLD gold satin



MRINX inox mirror

STINX inox satin



SMINX super mirror

 Stainless steel products can be produced in any requested height (h).

 Lengths (L) may vary according to surface options of stainless steel products.

MPS-S

Stainless Steel Tile Trim



MPS-S stainless steel tile trim internal corner profile adapts to trend ceramic colors and textures while adding aesthetics to your ceramic applications with its wide range of surface options. It is used in 90 degrees inner corner joints of ceramic applications. In addition to providing aesthetics that will eliminate joint and application flaws, it also prevents damage to ceramics. MPS-S has mirror, satin, exclusive super mirror surfaces and anthracite, bronze, copper, gold, inox color options. MPS-S can be produced in unlimited height and width options.

SOFTENS THE TRANSITION IN THE INNER CORNERS AND PROVIDES AN ELEGANT APPEARANCE



Product No	Height		Length		Surface
	mm	in	mm	ft	
MPS243014020STANT	8	5/16	2438	8	STANT
MPS243014020MRANT	8	5/16	2438	8	MRANT
MPS243014020STBRO	8	5/16	2438	8	STBRO
MPS243014020MRBRO	8	5/16	2438	8	MRBRO
MPS243014020STCOP	8	5/16	2438	8	STCOP
MPS243014020MRCOP	8	5/16	2438	8	MRCOP
MPS243014020STGLD	8	5/16	2438	8	STGLD
MPS243014020MRGLD	8	5/16	2438	8	MRGLD
MPS250014020STINX	8	5/16	2500	8 1/5"	STINX
MPS250014020MRINX	8	5/16	2500	8 1/5"	MRINX
MPS243014020SMINX	8	5/16	2438	8	SMINX
MPS243008020STANT	10	3/8	2438	8	STANT
MPS243008020MRANT	10	3/8	2438	8	MRANT
MPS243008020STBRO	10	3/8	2438	8	STBRO
MPS243008020MRBRO	10	3/8	2438	8	MRBRO
MPS243008020STCOP	10	3/8	2438	8	STCOP
MPS243008020MRCOP	10	3/8	2438	8	MRCOP
MPS243008020STGLD	10	3/8	2438	8	STGLD
MPS243008020MRGLD	10	3/8	2438	8	MRGLD
MPS250008020STINX	10	3/8	2500	8 1/5"	STINX
MPS250008020MRINX	10	3/8	2500	8 1/5"	MRINX
MPS243008020SMINX	10	3/8	2438	8	SMINX
MPS243010020STANT	12	1/2	2438	8	STANT
MPS243010020MRANT	12	1/2	2438	8	MRANT
MPS243010020STBRO	12	1/2	2438	8	STBRO
MPS243010020MRBRO	12	1/2	2438	8	MRBRO
MPS243010020STCOP	12	1/2	2438	8	STCOP
MPS243010020MRCOP	12	1/2	2438	8	MRCOP
MPS243010020STGLD	12	1/2	2438	8	STGLD
MPS243010020MRGLD	12	1/2	2438	8	MRGLD
MPS250010020STINX	12	1/2	2500	8 1/5"	STINX
MPS250010020MRINX	12	1/2	2500	8 1/5"	MRINX
MPS243010020SMINX	12	1/2	2438	8	SMINX
MPS243012020STANT	14	9/16	2438	8	STANT
MPS243012020MRANT	14	9/16	2438	8	MRANT
MPS243012020STBRO	14	9/16	2438	8	STBRO
MPS243012020MRBRO	14	9/16	2438	8	MRBRO
MPS243012020STCOP	14	9/16	2438	8	STCOP
MPS243012020MRCOP	14	9/16	2438	8	MRCOP
MPS243012020STGLD	14	9/16	2438	8	STGLD
MPS243012020MRGLD	14	9/16	2438	8	MRGLD
MPS250012020STINX	14	9/16	2500	8 1/5"	STINX
MPS250012020MRINX	14	9/16	2500	8 1/5"	MRINX
MPS243012020SMINX	14	9/16	2438	8	SMINX

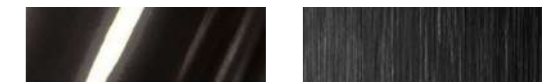
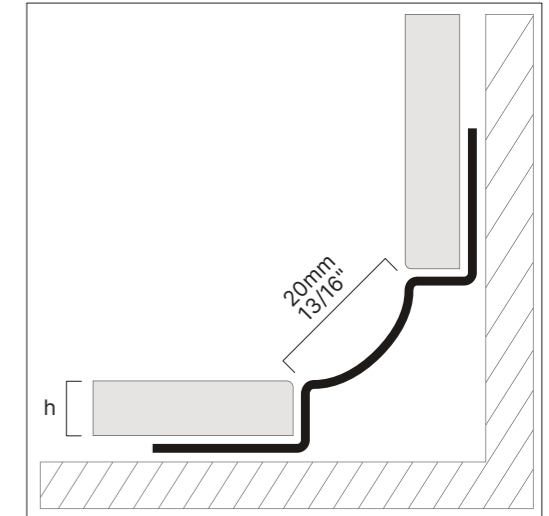

MRANT anthracite mirror

STANT anthracite satin



MRBRO bronze mirror

STBRO bronze satin



MRCOP copper mirror

STCOP copper satin



MRGLD gold mirror

STGLD gold satin



MRINX inox mirror

STINX inox satin



SMINX super mirror

Stainless steel products can be produced in any requested height (h).

Lengths (L) may vary according to surface options of stainless steel products.



RAMP TRANSITIONS, CARPET EDGE
PROTECTION, **FLOORING AND
RENOVATION**, STEP NOSE PROTECTION

Mox flooring profiles cover the gaps between flooring or door threshold transitions, hiding any application defect. In addition to standard threshold profiles, they also include ramp profiles that eliminate level differences between floors.

ALL IN ONE

Aluminum Ramp Transition

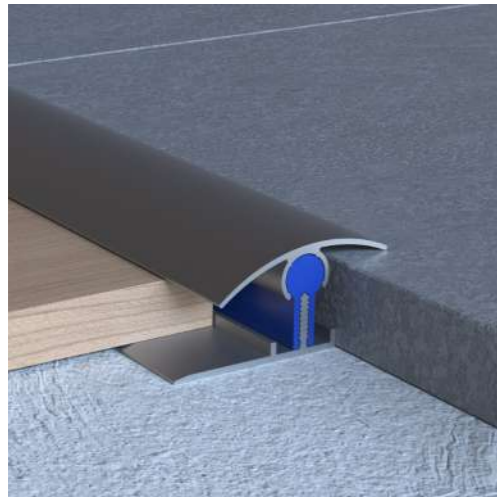

All in One aluminium ramp transition profile provides transition by eliminating any level difference between two different flooring materials in floor applications. With its adjustable feature, it adapts to every level difference between floorings. Unlike its competitors it can be installed from its extension beneath the floorings and doesn't require adhesives which makes it more long-lasting. All in One has matte anodized, bright anodized, satin chemical bright anodized and electrostatic powder painting options. While silver, yellow, inox, bronze and black anodized color coatings are available, it can also be painted to the desired RAL code with electrostatic powder painting.

WITH ITS ADJUSTABILITY, IT PROVIDES A FLAWLESS APPEARANCE TO FLOOR TRANSITIONS



Product No	Height		Length		Surface
	mm	in	mm	ft	
AIO25004024MEGMS	hmax 24 hmin 1.5	15/16 1/16	2500	8 1/5"	MEGMS
AIO25004024MESAR	hmax 24 hmin 1.5	15/16 1/16	2500	8 1/5"	MESAR
AIO25004024MEINX	hmax 24 hmin 1.5	15/16 1/16	2500	8 1/5"	MEINX
AIO25004024MESYH	hmax 24 hmin 1.5	15/16 1/16	2500	8 1/5"	MESYH

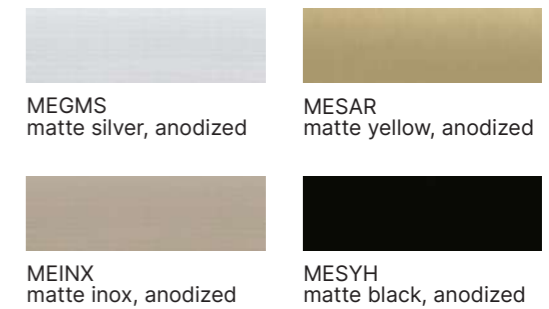
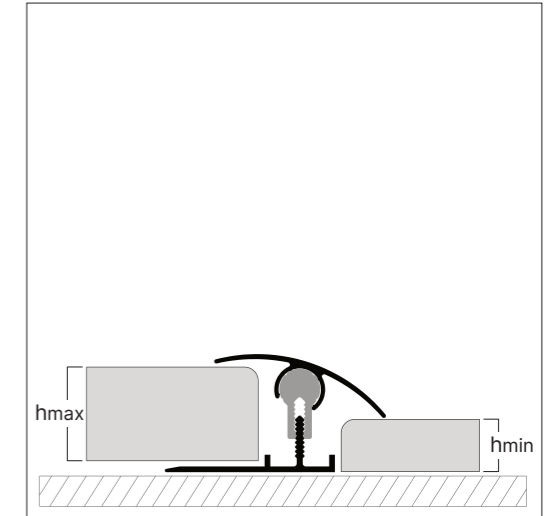
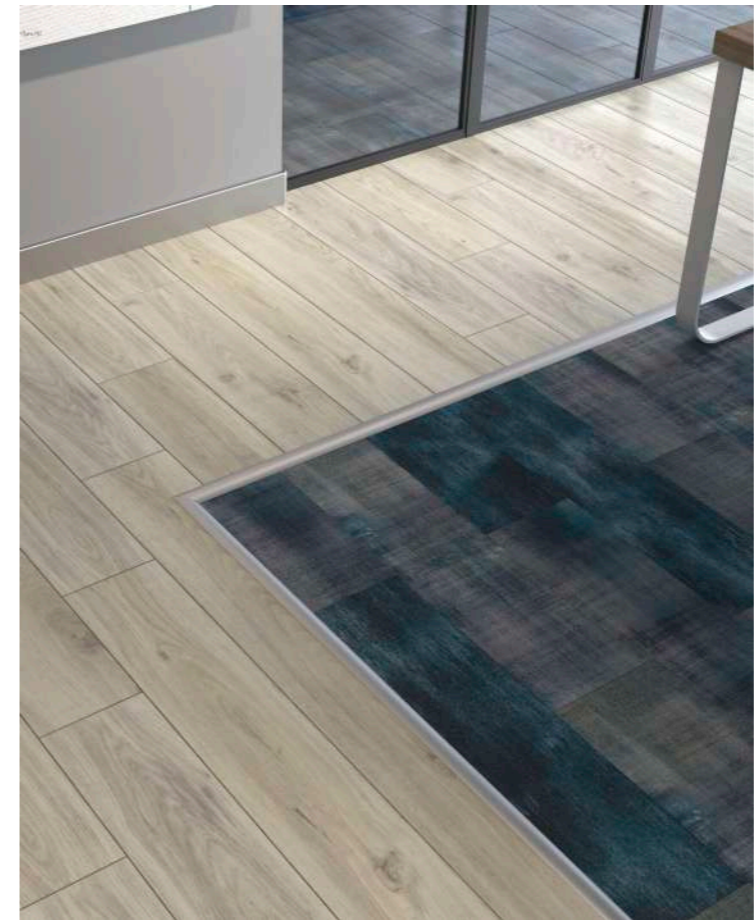

REVIO

Aluminum Flooring

Revio aluminum carpet edge profile is specially designed to increase the aesthetics and functionality of your floor. Revio aluminum carpet edge profile not only provides a seamless transition between different flooring surfaces, but also protects the edges of your carpet, preventing wear and deformation that may occur over time. These profiles help you reduce repair and replacement costs by extending the life of your carpet.

Revio has a matte anodized coating option in silver, yellow and inox colors.



DESIGNED TO ENHANCE THE AESTHETICS AND FUNCTIONALITY OF YOUR FLOORING



Product No	Height		Length		Surface
	mm	in	mm	ft	
RVO25001215MEGMS	12	1/2	2500	8 1/5"	MEGMS
RVO25001215MESAR	12	1/2	2500	8 1/5"	MESAR
RVO25001215MEINX	12	1/2	2500	8 1/5"	MEINX

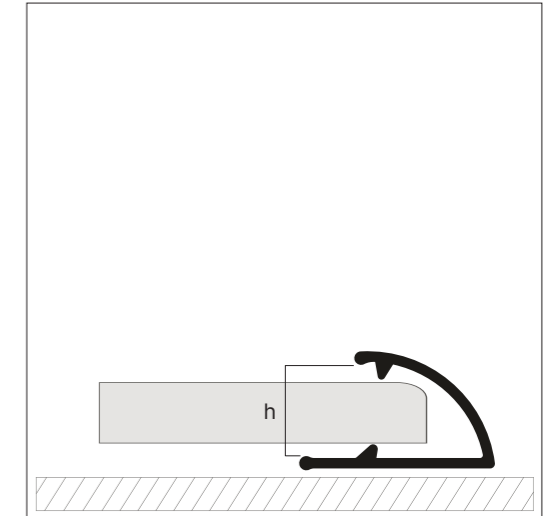

MEGMS
matte silver, anodized



MESAR
matte yellow, anodized



MEINX
matte inox, anodized

VISIO

Aluminum Flooring



Visio aluminum carpet threshold profile provides safe, aesthetic and long-lasting interior transitions between different flooring materials. It creates a safe environment, especially for children and the elderly, by providing a smooth transition between different flooring heights. Visio aluminum carpet threshold profile is designed to close gaps between carpet and other floor coverings. It provides a smooth transition between carpet and other floor covering types, eliminating any irregularities or tripping hazards that may occur. It also prolongs the life of carpets by protecting them against wear and tear. Visio, which has an aesthetic appearance as well as functional advantages, improves the overall appearance of your interior design. Visio aluminum carpet threshold profile has a matte anodized coating option in silver, yellow and inox colors.

ENHANCE YOUR FLOORING TRANSITION WITH A STYLISH CARPET THRESHOLD PROFILE



Product No	Height		Length		Surface
	mm	in	mm	ft	
VSO25000927MEGMS	h1 9 h2 6.3	3/8 1/4	2500	8 1/5"	MEGMS
VSO25000927MESAR	h1 9 h2 6.3	3/8 1/4	2500	8 1/5"	MESAR
VSO25000927MEINX	h1 9 h2 6.3	3/8 1/4	2500	8 1/5"	MEINX
VSO09000927MEGMS	h1 9 h2 6.3	3/8 1/4	900	2 31/32"	MEGMS
VSO09000927MESAR	h1 9 h2 6.3	3/8 1/4	900	2 31/32"	MESAR
VSO09000927MEINX	h1 9 h2 6.3	3/8 1/4	900	2 31/32"	MEINX

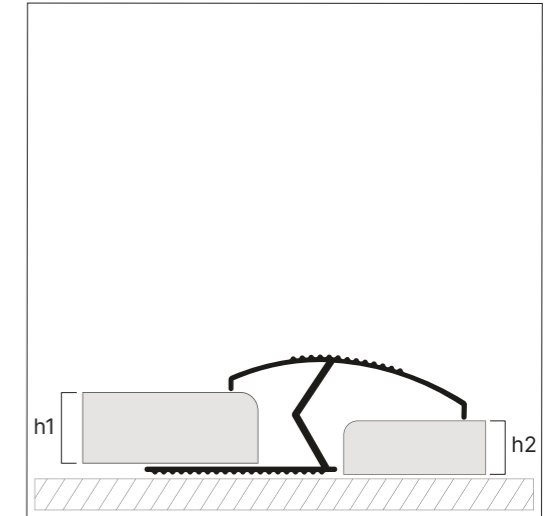
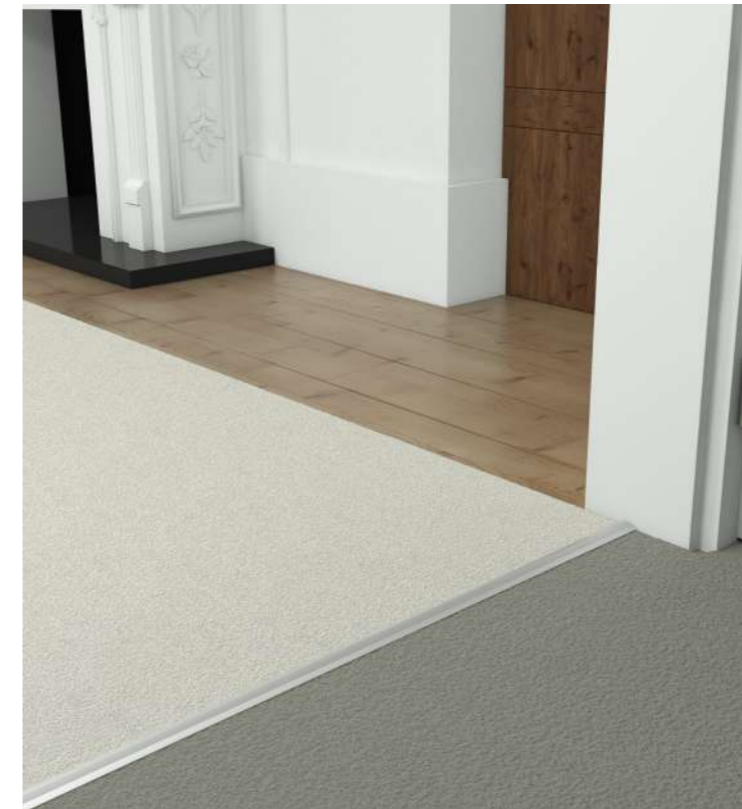

MEGMS
matte silver, anodized



MESAR
matte yellow, anodized



MEINX
matte inox, anodized

LINE

Aluminum Flooring



Line aluminum flooring edge profile is an excellent choice for various projects with its versatile, durable and lightweight structure that closes the gap between floorings. Line aluminum flooring edge profile is designed to close the gaps between floor tiles of the same height. Line aluminum flooring edge profile has a bright anodized coating option in silver and yellow colors.

PERFECT CHOICE FOR YOUR FLOORING WITH ITS MINIMALIST FORM



Product No	Height		Length		Surface
	mm	in	mm	ft	
LIN25001004PEGMS	10	3/8	2500	8 1/5"	PEGMS
LIN25001004PESAR	10	3/8	2500	8 1/5"	PESAR

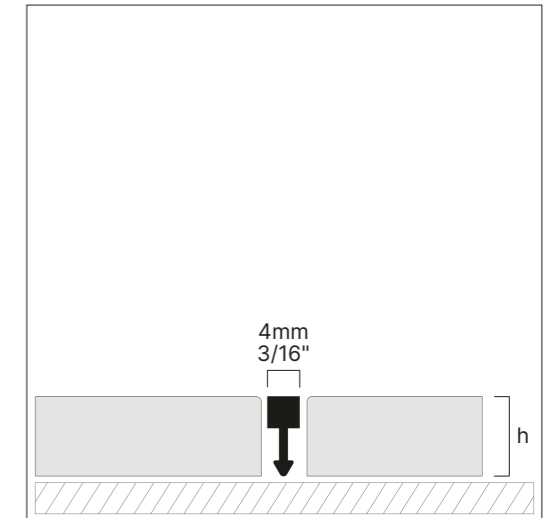

FLEX

Aluminum Flooring



Flex aluminum formable flooring edge profile is used in parquet or ceramic applications as a frame that conceals the floor section, replacing joints. In addition to correcting joint and installation mistakes and improving aesthetics, it also prevents damage to the floor coverings. Flex aluminum formable flooring edge profile is designed to facilitate the transition of flooring materials. Its flexible design allows it to be bent into the desired shape. In addition to its functional advantages, its minimal appearance enhances the overall look of your designs.

Flex has matte anodized, bright anodized and electrostatic powder painting options. While silver, yellow, inox and black anodized color coatings are available, it can also be painted to the desired RAL code with electrostatic powder painting.

CREATE IMAGINATIVE DESIGNS FOR YOUR FLOORING WITH ITS FORMABLE FORM



Product No	Height		Length		Surface
	mm	in	mm	ft	
FLX250010003MEGMS	10	3/8	2500	8 1/5"	MEGMS
FLX250010003MESAR	10	3/8	2500	8 1/5"	MESAR
FLX250010003MEINX	10	3/8	2500	8 1/5"	MEINX
FLX250010003MESYH	10	3/8	2500	8 1/5"	MESYH
FLX250010003PEGMS	10	3/8	2500	8 1/5"	PEGMS
FLX250010003PESAR	10	3/8	2500	8 1/5"	PESAR
FLX250010003PEINX	10	3/8	2500	8 1/5"	PEINX
FLX250010003PESYH	10	3/8	2500	8 1/5"	PESYH
FLX250010003R9016	10	3/8	2500	8 1/5"	R9016
FLX250010003R7016	10	3/8	2500	8 1/5"	R7016

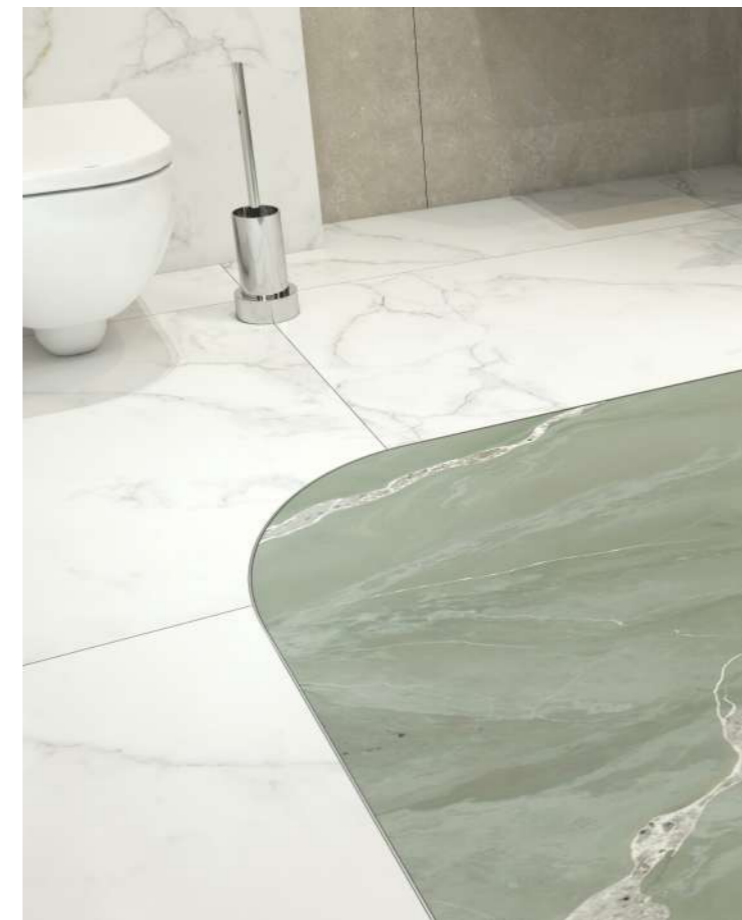
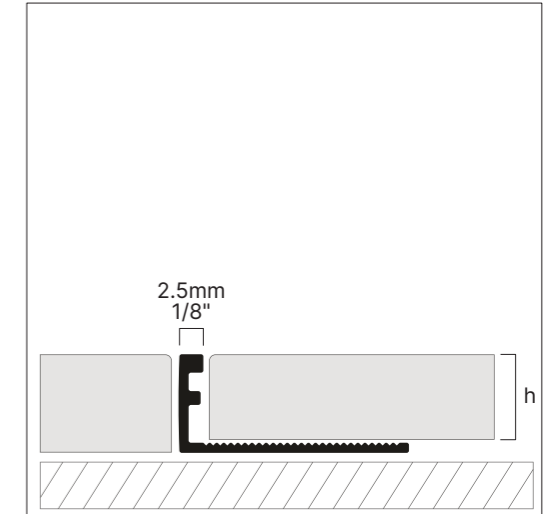

MEGMS matte silver, anodized	MESAR matte yellow, anodized
MEINX matte inox, anodized	MESYH matte black, anodized
PEGMS bright silver, anodized	PESAR bright yellow, anodized
PEINX bright inox, anodized	PESYH bright black, anodized
R9016 white, semi gloss, powder coated	R7016 anthracite, semi gloss, powder coated

MPS-E

Stainless Steel Flooring Profile

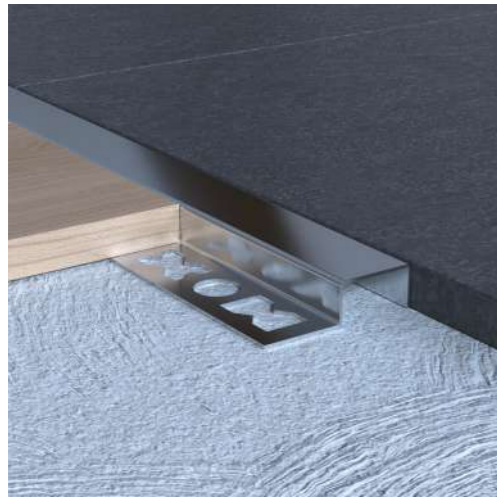

MPS-E stainless steel floor transition profile is one of the most preferred transition profiles. Unlike its competitors it can be installed from its extension beneath the flooring and doesn't require adhesives which makes it more long-lasting. It is used as a transition border in flooring applications. MPS-E has mirror, satin, exclusive super mirror surfaces and anthracite, bronze, copper, gold, inox color options. MPS-E can be produced in unlimited height and width options.

SUITABLE FOR ALL ARCHITECTURAL DESIGNS WITH ITS TRADITIONAL BUT ENHANCED APPEARANCE



Product No	Height		Length		Surface
	mm	in	mm	ft	
MPE243010020STANT	8	5/16	2438	8	STANT
MPE243010020MRANT	8	5/16	2438	8	MRANT
MPE243010020STBRO	8	5/16	2438	8	STBRO
MPE243010020MRBRO	8	5/16	2438	8	MRBRO
MPE243010020STCOP	8	5/16	2438	8	STCOP
MPE243010020MRCOP	8	5/16	2438	8	MRCOP
MPE243010020STGLD	8	5/16	2438	8	STGLD
MPE243010020MRGLD	8	5/16	2438	8	MRGLD
MPE250010020STINX	8	5/16	2500	8 1/5"	STINX
MPE250010020MRINX	8	5/16	2500	8 1/5"	MRINX
MPE243010020SMINX	8	5/16	2438	8	SMINX
MPE243012020STANT	10	3/8	2438	8	STANT
MPE243012020MRANT	10	3/8	2438	8	MRANT
MPE243012020STBRO	10	3/8	2438	8	STBRO
MPE243012020MRBRO	10	3/8	2438	8	MRBRO
MPE243012020STCOP	10	3/8	2438	8	STCOP
MPE243012020MRCOP	10	3/8	2438	8	MRCOP
MPE243012020STGLD	10	3/8	2438	8	STGLD
MPE243012020MRGLD	10	3/8	2438	8	MRGLD
MPE250012020STINX	10	3/8	2500	8 1/5"	STINX
MPE250012020MRINX	10	3/8	2500	8 1/5"	MRINX
MPE243012020SMINX	10	3/8	2438	8	SMINX
MPE243014020STANT	12	1/2	2438	8	STANT
MPE243014020MRANT	12	1/2	2438	8	MRANT
MPE243014020STBRO	12	1/2	2438	8	STBRO
MPE243014020MRBRO	12	1/2	2438	8	MRBRO
MPE243014020STCOP	12	1/2	2438	8	STCOP
MPE243014020MRCOP	12	1/2	2438	8	MRCOP
MPE243014020STGLD	12	1/2	2438	8	STGLD
MPE243014020MRGLD	12	1/2	2438	8	MRGLD
MPE250014020STINX	12	1/2	2500	8 1/5"	STINX
MPE250014020MRINX	12	1/2	2500	8 1/5"	MRINX
MPE243014020SMINX	12	1/2	2438	8	SMINX
MPE243008020STANT	14	9/16	2438	8	STANT
MPE243008020MRANT	14	9/16	2438	8	MRANT
MPE243008020STBRO	14	9/16	2438	8	STBRO
MPE243008020MRBRO	14	9/16	2438	8	MRBRO
MPE243008020STCOP	14	9/16	2438	8	STCOP
MPE243008020MRCOP	14	9/16	2438	8	MRCOP
MPE243008020STGLD	14	9/16	2438	8	STGLD
MPE243008020MRGLD	14	9/16	2438	8	MRGLD
MPE250008020STINX	14	9/16	2500	8 1/5"	STINX
MPE250008020MRINX	14	9/16	2500	8 1/5"	MRINX
MPE243008020SMINX	14	9/16	2438	8	SMINX

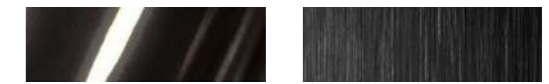
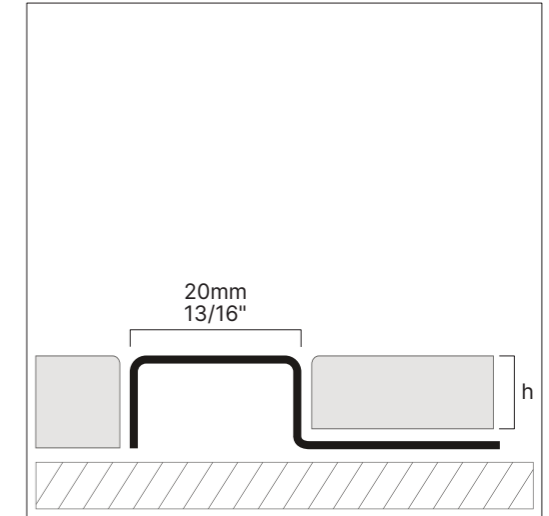

MRANT anthracite mirror

STANT anthracite satin



MRBRO bronze mirror

STBRO bronze satin



MRCOP copper mirror

STCOP copper satin



MRGLD gold mirror

STGLD gold satin



MRINX inox mirror

STINX inox satin



SMINX super mirror

Stainless steel products can be produced in any requested height (h).

Lengths (L) may vary according to surface options of stainless steel products.

MPS-N

Stainless Steel Flooring Profile

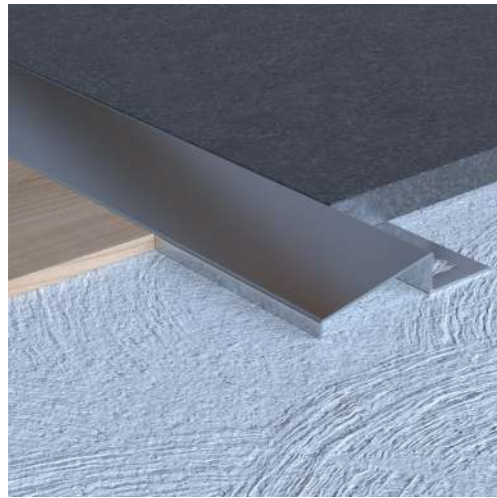

MPS-N stainless steel ramp transition profile is used as a separating border and transition profile between floors of different levels in floor applications. It can be produced in custom heights for any level difference.

MPS-N has mirror, satin, exclusive super mirror surfaces and anthracite, bronze, copper, gold, inox color options. MPS-N can be produced in unlimited height and width options.

SOFTENS THE TRANSITION BETWEEN DIFFERENT LEVELS



Product No	Height		Length		Surface
	mm	in	mm	ft	
MPN243014050STANT	8	5/16	2438	8	STANT
MPN243014050MRANT	8	5/16	2438	8	MRANT
MPN243014050STBRO	8	5/16	2438	8	STBRO
MPN243014050MRBRO	8	5/16	2438	8	MRBRO
MPN243014050STCOP	8	5/16	2438	8	STCOP
MPN243014050MRCOP	8	5/16	2438	8	MRCOP
MPN243014050STGLD	8	5/16	2438	8	STGLD
MPN243014050MRGLD	8	5/16	2438	8	MRGLD
MPN250014050STINX	8	5/16	2500	8 1/5"	STINX
MPN250014050MRINX	8	5/16	2500	8 1/5"	MRINX
MPN243014050SMINX	8	5/16	2438	8	SMINX
MPN243008050STANT	10	3/8	2438	8	STANT
MPN243008050MRANT	10	3/8	2438	8	MRANT
MPN243008050STBRO	10	3/8	2438	8	STBRO
MPN243008050MRBRO	10	3/8	2438	8	MRBRO
MPN243008050STCOP	10	3/8	2438	8	STCOP
MPN243008050MRCOP	10	3/8	2438	8	MRCOP
MPN243008050STGLD	10	3/8	2438	8	STGLD
MPN243008050MRGLD	10	3/8	2438	8	MRGLD
MPN250008050STINX	10	3/8	2500	8 1/5"	STINX
MPN250008050MRINX	10	3/8	2500	8 1/5"	MRINX
MPN243008050SMINX	10	3/8	2438	8	SMINX
MPN243010050STANT	12	1/2	2438	8	STANT
MPN243010050MRANT	12	1/2	2438	8	MRANT
MPN243010050STBRO	12	1/2	2438	8	STBRO
MPN243010050MRBRO	12	1/2	2438	8	MRBRO
MPN243010050STCOP	12	1/2	2438	8	STCOP
MPN243010050MRCOP	12	1/2	2438	8	MRCOP
MPN243010050STGLD	12	1/2	2438	8	STGLD
MPN243010050MRGLD	12	1/2	2438	8	MRGLD
MPN250010050STINX	12	1/2	2500	8 1/5"	STINX
MPN250010050MRINX	12	1/2	2500	8 1/5"	MRINX
MPN243010050SMINX	12	1/2	2438	8	SMINX
MPN243012050STANT	14	9/16	2438	8	STANT
MPN243012050MRANT	14	9/16	2438	8	MRANT
MPN243012050STBRO	14	9/16	2438	8	STBRO
MPN243012050MRBRO	14	9/16	2438	8	MRBRO
MPN243012050STCOP	14	9/16	2438	8	STCOP
MPN243012050MRCOP	14	9/16	2438	8	MRCOP
MPN243012050STGLD	14	9/16	2438	8	STGLD
MPN243012050MRGLD	14	9/16	2438	8	MRGLD
MPN250012050STINX	14	9/16	2500	8 1/5"	STINX
MPN250012050MRINX	14	9/16	2500	8 1/5"	MRINX
MPN243012050SMINX	14	9/16	2438	8	SMINX

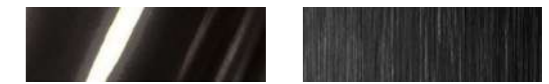
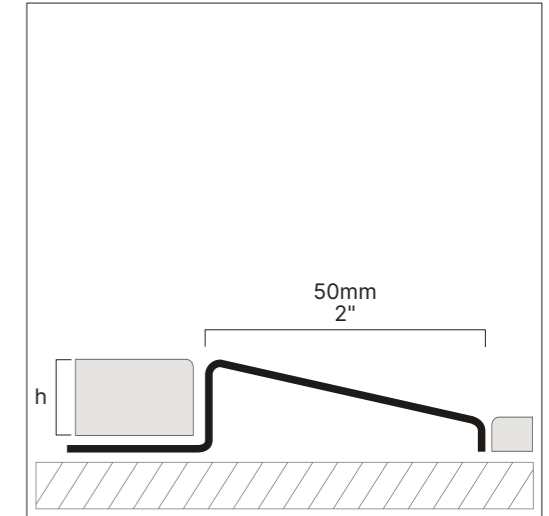

MRANT anthracite mirror

STANT anthracite satin



MRBRO bronze mirror

STBRO bronze satin



MRCOP copper mirror

STCOP copper satin



MRGLD gold mirror

STGLD gold satin



MRINX inox mirror

STINX inox satin



SMINX super mirror

Stainless steel products can be produced in any requested height (h).

Lengths (L) may vary according to surface options of stainless steel products.

MPS-TB

Stainless Steel Flooring Profile

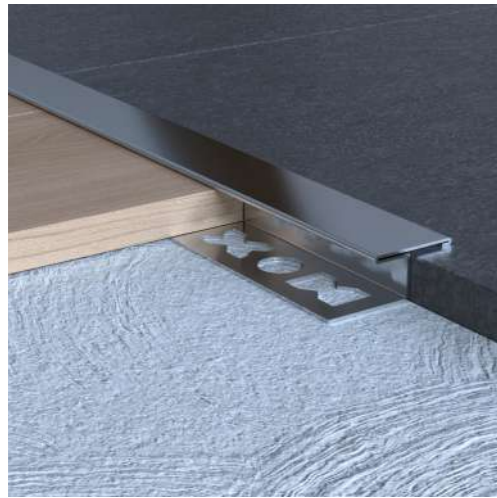

MPS-TB stainless steel floor T transition is one of the most durable transition profiles. Unlike its competitors it can be installed from its extension beneath the flooring and doesn't require adhesives which makes it more long-lasting. It covers the gaps and application flaws between floor transitions and door threshold transitions. It is also used as a separator frame in floor applications. MPS-TB has mirror, satin, exclusive super mirror surfaces and anthracite, bronze, copper, gold, inox color options. MPS-TB can be produced in unlimited height and width options.

WITH THE T SHAPE, PROVIDES THE SIMPLE LOOK OF TRADITIONAL TRANSITIONS



Product No	Height		Length		Surface
	mm	in	mm	ft	
MTB243010025STANT	8	5/16	2438	8	STANT
MTB243010025MRANT	8	5/16	2438	8	MRANT
MTB243010025STBRO	8	5/16	2438	8	STBRO
MTB243010025MRBRO	8	5/16	2438	8	MRBRO
MTB243010025STCOP	8	5/16	2438	8	STCOP
MTB243010025MRCOP	8	5/16	2438	8	MRCOP
MTB243010025STGLD	8	5/16	2438	8	STGLD
MTB243010025MRGLD	8	5/16	2438	8	MRGLD
MTB250010025STINX	8	5/16	2500	8 1/5"	STINX
MTB250010025MRINX	8	5/16	2500	8 1/5"	MRINX
MTB243010025SMINX	8	5/16	2438	8	SMINX
MTB243012025STANT	10	3/8	2438	8	STANT
MTB243012025MRANT	10	3/8	2438	8	MRANT
MTB243012025STBRO	10	3/8	2438	8	STBRO
MTB243012025MRBRO	10	3/8	2438	8	MRBRO
MTB243012025STCOP	10	3/8	2438	8	STCOP
MTB243012025MRCOP	10	3/8	2438	8	MRCOP
MTB243012025STGLD	10	3/8	2438	8	STGLD
MTB243012025MRGLD	10	3/8	2438	8	MRGLD
MTB250012025STINX	10	3/8	2500	8 1/5"	STINX
MTB250012025MRINX	10	3/8	2500	8 1/5"	MRINX
MTB243012025SMINX	10	3/8	2438	8	SMINX
MTB243014025STANT	12	1/2	2438	8	STANT
MTB243014025MRANT	12	1/2	2438	8	MRANT
MTB243014025STBRO	12	1/2	2438	8	STBRO
MTB243014025MRBRO	12	1/2	2438	8	MRBRO
MTB243014025STCOP	12	1/2	2438	8	STCOP
MTB243014025MRCOP	12	1/2	2438	8	MRCOP
MTB243014025STGLD	12	1/2	2438	8	STGLD
MTB243014025MRGLD	12	1/2	2438	8	MRGLD
MTB250014025STINX	12	1/2	2500	8 1/5"	STINX
MTB250014025MRINX	12	1/2	2500	8 1/5"	MRINX
MTB243014025SMINX	12	1/2	2438	8	SMINX
MTB243008025STANT	14	9/16	2438	8	STANT
MTB243008025MRANT	14	9/16	2438	8	MRANT
MTB243008025STBRO	14	9/16	2438	8	STBRO
MTB243008025MRBRO	14	9/16	2438	8	MRBRO
MTB243008025STCOP	14	9/16	2438	8	STCOP
MTB243008025MRCOP	14	9/16	2438	8	MRCOP
MTB243008025STGLD	14	9/16	2438	8	STGLD
MTB243008025MRGLD	14	9/16	2438	8	MRGLD
MTB250008025STINX	14	9/16	2500	8 1/5"	STINX
MTB250008025MRINX	14	9/16	2500	8 1/5"	MRINX
MTB243008025SMINX	14	9/16	2438	8	SMINX

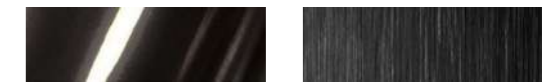
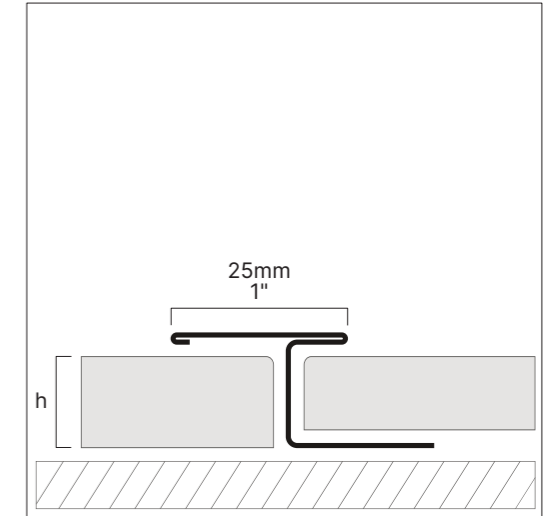

MRANT anthracite mirror

STANT anthracite satin



MRBRO bronze mirror

STBRO bronze satin



MRCOP copper mirror

STCOP copper satin



MRGLD gold mirror

STGLD gold satin



MRINX inox mirror

STINX inox satin



SMINX super mirror

Stainless steel products can be produced in any requested height (h).

Lengths (L) may vary according to surface options of stainless steel products.

MPS-YD

Stainless Steel Flooring Profile

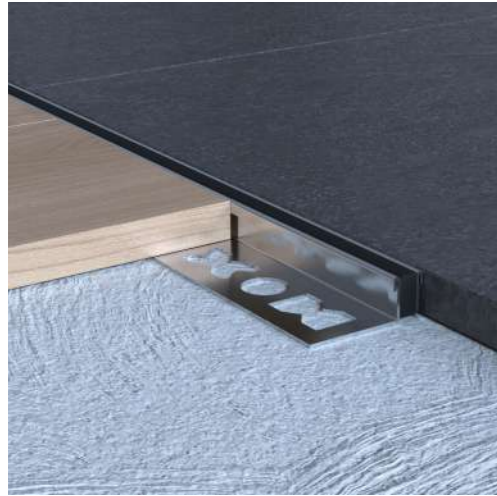

MPS-YD stainless steel expansion joint profile provides the best solutions for ceramic floor applications especially in places with large areas such as hospitals, shopping malls and schools. It absorbs the pressure caused by structural expansions and provides protection to ceramics. MPS-YD has mirror, satin, exclusive super mirror surfaces and anthracite, bronze, copper, gold, inox color options. MPS-YD can be produced in unlimited height and width options.

ABSORBS THE PRESSURE OF BUILDING EXPANSIONS AND PROVIDES PROTECTION TO CERAMICS



Product No	Height		Length		Surface
	mm	in	mm	ft	
MYD243014015STANT	8	5/16	2438	8	STANT
MYD243014015MRANT	8	5/16	2438	8	MRANT
MYD243014015STBRO	8	5/16	2438	8	STBRO
MYD243014015MRBRO	8	5/16	2438	8	MRBRO
MYD243014015STCOP	8	5/16	2438	8	STCOP
MYD243014015MRCOP	8	5/16	2438	8	MRCOP
MYD243014015STGLD	8	5/16	2438	8	STGLD
MYD243014015MRGLD	8	5/16	2438	8	MRGLD
MYD250014015STINX	8	5/16	2500	8 1/5"	STINX
MYD250014015MRINX	8	5/16	2500	8 1/5"	MRINX
MYD243014015SMINX	8	5/16	2438	8	SMINX
MYD243008015STANT	10	3/8	2438	8	STANT
MYD243008015MRANT	10	3/8	2438	8	MRANT
MYD243008015STBRO	10	3/8	2438	8	STBRO
MYD243008015MRBRO	10	3/8	2438	8	MRBRO
MYD243008015STCOP	10	3/8	2438	8	STCOP
MYD243008015MRCOP	10	3/8	2438	8	MRCOP
MYD243008015STGLD	10	3/8	2438	8	STGLD
MYD243008015MRGLD	10	3/8	2438	8	MRGLD
MYD250008015STINX	10	3/8	2500	8 1/5"	STINX
MYD250008015MRINX	10	3/8	2500	8 1/5"	MRINX
MYD243008015SMINX	10	3/8	2438	8	SMINX
MYD243010015STANT	12	1/2	2438	8	STANT
MYD243010015MRANT	12	1/2	2438	8	MRANT
MYD243010015STBRO	12	1/2	2438	8	STBRO
MYD243010015MRBRO	12	1/2	2438	8	MRBRO
MYD243010015STCOP	12	1/2	2438	8	STCOP
MYD243010015MRCOP	12	1/2	2438	8	MRCOP
MYD243010015STGLD	12	1/2	2438	8	STGLD
MYD243010015MRGLD	12	1/2	2438	8	MRGLD
MYD250010015STINX	12	1/2	2500	8 1/5"	STINX
MYD250010015MRINX	12	1/2	2500	8 1/5"	MRINX
MYD243010015SMINX	12	1/2	2438	8	SMINX
MYD243012015STANT	14	9/16	2438	8	STANT
MYD243012015MRANT	14	9/16	2438	8	MRANT
MYD243012015STBRO	14	9/16	2438	8	STBRO
MYD243012015MRBRO	14	9/16	2438	8	MRBRO
MYD243012015STCOP	14	9/16	2438	8	STCOP
MYD243012015MRCOP	14	9/16	2438	8	MRCOP
MYD243012015STGLD	14	9/16	2438	8	STGLD
MYD243012015MRGLD	14	9/16	2438	8	MRGLD
MYD250012015STINX	14	9/16	2500	8 1/5"	STINX
MYD250012015MRINX	14	9/16	2500	8 1/5"	MRINX
MYD243012015SMINX	14	9/16	2438	8	SMINX

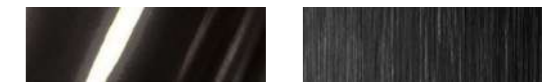
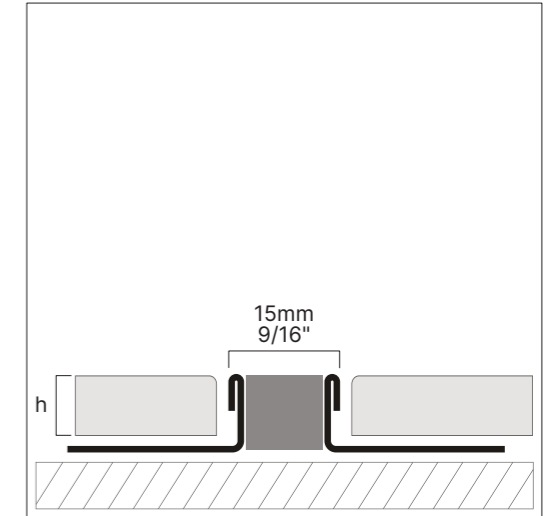

MRANT anthracite mirror

STANT anthracite satin



MRBRO bronze mirror

STBRO bronze satin



MRCOP copper mirror

STCOP copper satin



MRGLD gold mirror

STGLD gold satin



MRINX inox mirror

STINX inox satin



SMINX super mirror

Stainless steel products can be produced in any requested height (h).

Lengths (L) may vary according to surface options of stainless steel products.

MPS-B

Stainless Steel Step Nose

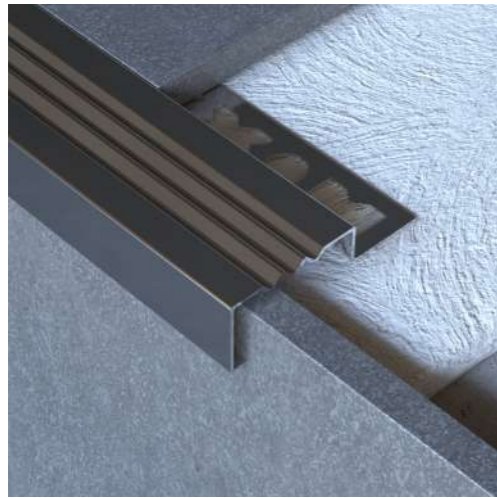

MPS-B stainless steel tile step protection profile covers the defects caused during application and protects the step tiles such as marble and parquet. It protects ceramic steps against deformation and fracture while providing safety with its non-slip design. MPS-B has mirror, satin, exclusive super mirror surfaces and anthracite, bronze, copper, gold, inox color options. MPS-B can be produced in unlimited height and width options.

ELIMINATES APPLICATION ERRORS OF STAIRS SUCH AS MARBLE AND PARQUET

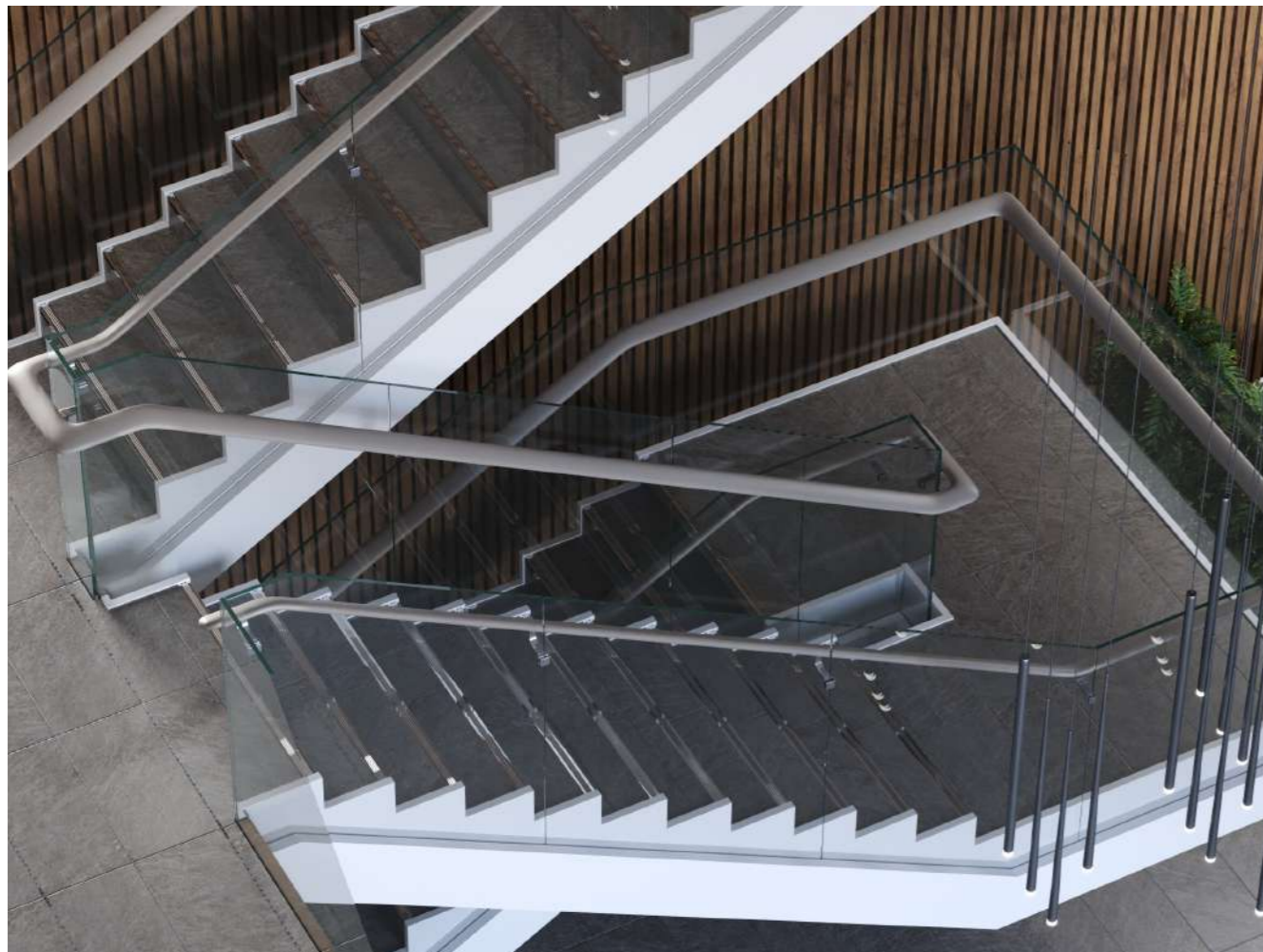

Product No	Height		Length		Surface
	mm	in	mm	ft	
MPB243010040STANT	10	3/8	2438	8	STANT
MPB243010040MRANT	10	3/8	2438	8	MRANT
MPB243010040STBRO	10	3/8	2438	8	STBRO
MPB243010040MRBRO	10	3/8	2438	8	MRBRO
MPB243010040STCOP	10	3/8	2438	8	STCOP
MPB243010040MRCOP	10	3/8	2438	8	MRCOP
MPB243010040STGLD	10	3/8	2438	8	STGLD
MPB243010040MRGLD	10	3/8	2438	8	MRGLD
MPB250010040STINX	10	3/8	2500	8 1/5"	STINX
MPB250010040MRINX	10	3/8	2500	8 1/5"	MRINX
MPB243010040SMINX	10	3/8	2438	8	SMINX
MPB243012040STANT	12	1/2	2438	8	STANT
MPB243012040MRANT	12	1/2	2438	8	MRANT
MPB243012040STBRO	12	1/2	2438	8	STBRO
MPB243012040MRBRO	12	1/2	2438	8	MRBRO
MPB243012040STCOP	12	1/2	2438	8	STCOP
MPB243012040MRCOP	12	1/2	2438	8	MRCOP
MPB243012040STGLD	12	1/2	2438	8	STGLD
MPB243012040MRGLD	12	1/2	2438	8	MRGLD
MPB250012040STINX	12	1/2	2500	8 1/5"	STINX
MPB250012040MRINX	12	1/2	2500	8 1/5"	MRINX
MPB243012040SMINX	12	1/2	2438	8	SMINX
MPB243014040STANT	14	9/16	2438	8	STANT
MPB243014040MRANT	14	9/16	2438	8	MRANT
MPB243014040STBRO	14	9/16	2438	8	STBRO
MPB243014040MRBRO	14	9/16	2438	8	MRBRO
MPB243014040STCOP	14	9/16	2438	8	STCOP
MPB243014040MRCOP	14	9/16	2438	8	MRCOP
MPB243014040STGLD	14	9/16	2438	8	STGLD
MPB243014040MRGLD	14	9/16	2438	8	MRGLD
MPB250014040STINX	14	9/16	2500	8 1/5"	STINX
MPB250014040MRINX	14	9/16	2500	8 1/5"	MRINX
MPB243014040SMINX	14	9/16	2438	8	SMINX
MPB243020040STANT	20	13/16	2438	8	STANT
MPB243020040MRANT	20	13/16	2438	8	MRANT
MPB243020040STBRO	20	13/16	2438	8	STBRO
MPB243020040MRBRO	20	13/16	2438	8	MRBRO
MPB243020040STCOP	20	13/16	2438	8	STCOP
MPB243020040MRCOP	20	13/16	2438	8	MRCOP
MPB243020040STGLD	20	13/16	2438	8	STGLD
MPB243020040MRGLD	20	13/16	2438	8	MRGLD
MPB250020040STINX	20	13/16	2500	8 1/5"	STINX
MPB250020040MRINX	20	13/16	2500	8 1/5"	MRINX
MPB243020040SMINX	20	13/16	2438	8	SMINX

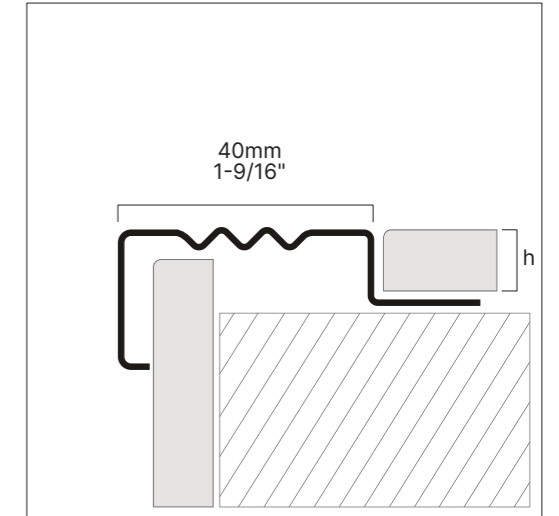

MRANT anthracite mirror

STANT anthracite satin



MRBRO bronze mirror

STBRO bronze satin



MRCOP copper mirror

STCOP copper satin



MRGLD gold mirror

STGLD gold satin



MRINX inox mirror

STINX inox satin



SMINX super mirror

Stainless steel products can be produced in any requested height (h).

Lengths (L) may vary according to surface options of stainless steel products.

Istanbul Office
EGS Business Park B1 No 394
Yesilkoy, Istanbul, Turkey
+90 212 559 0636

UK Warehouse
869 High Road Tottenham,
London, N17 8EY, UK
+44 751 2934322

mox@moxsystems.com
moxsystems.com